



F HRER®



*Hidrolik Lift İmalatı ve
Trakt r Yedek Paraları*

BİZ

Firmamız yılların verdiği bilgi birikimi ve tecrübesi ile barındırdığı profesyonel ekibi ve geliştirdiği kalite anlayışıyla hizmete başlamıştır. Kurulduğu günden itibaren sahip olduğu değerlerle profesyonel olarak çalışan FÜHRER her alanda kaliteyi ön planda tutmuş, satış sonrasında da müşterilerinin yanında olarak yenilikçi çözümler üretmeyi ilke edinmiştir. Daima müşteri odaklı çalışan kurumumuz üretimin her aşamasında titizlikle çalışmalarına devam etmiş ve lider bir firma olmayı hedeflemiştir. Firmamız her zaman kaliteyi, üretmeyi, müşteri beklentilerini zamanında ve eksiksiz yerine getirmeyi amaçlamaktadır. Bu amaç doğrultusunda ürün çeşitliliğini artırarak ulusal ve uluslararası firma kimliği oluşturmayı prensip edinmiştir.



KALİTE POLİTİKAMIZ

Müşterilerimizin değişen – gelişen şartlarını göz önüne alarak ihtiyaç ve beklentilerini doğru algılayıp istenilen şekilde, sürekli ve zamanında karşılayarak müşteri memnuniyetini sağlamak,

Sektörümüzle ilgili teknolojik gelişmeleri takip ederek üretim ve hizmetlerimizde en gelişmiş teknikleri kullanmak,

Ürün ve hizmet kalitemizi artırmak için çalışanlarımızın katılımını sağlayarak memnuniyetleri, motivasyonları ve eğitimleri için gereken tedbirleri almak.

Fire oranlarını azaltıp maliyetleri optimum seviyeye çekmek ve kalitesi verimliliği ve rekabet gücü yüksek kuruluş olmak,

Çevreye saygılı, iş ve işçi güvenliğini temel alan, yasal mevzuat şartlarına ve diğer yerli – yabancı standartlara uygun olarak üretim yapmak.

Kalite yönetim sistemimizi belirli dönemlerde gözden geçirerek etkinliğini artırmak ve sürekli iyileştirmek.

“

Liderlik,
ürün ve üretiminin
müşteri tarafından
takdir edilmesidir.



ŞİRKET DEĞERLERİMİZ



ZAMAN YÖNETİMİ

Zaman yönetmek demek en kısa sürede müşterinin ihtiyacı olan ürünü en iyi kalitede üretip ulaştırmaktır.

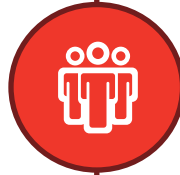

EKİP YÖNETİMİ

Ekip yönetimi, ekip ruhuyla tek yumruk, tek vücut olup profesyonel çözümleri sunmaktır.



AR-GE

Araştırmak, araştırmak ve yine araştırmak...Müşterinin işini en uygun maliyetle en pratik ve ergonomik şekilde teknoloji ile çözmek için araştırmak...





Traktörün gücü, kası, eli, ayağıyız...

Kumandadan, lifte, yedek parçadan krikoya ihtiyacınız olan ne varsa Führrer ile yanibaşınızda...

Büyük İşler Başarmanın Yolu
O işi Sevmektir...



Emekten, Bereketi...



A
model

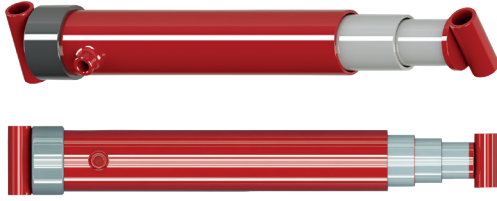

B
model

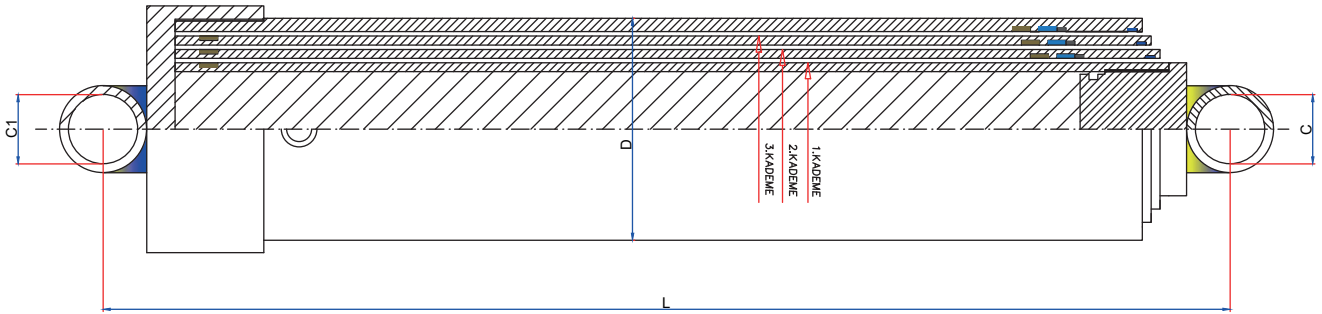

TEKNİK ÖZELLİKLER

Stok Kodu	Kademe	Kapalı Merkez L - (cm)	Kapasite (Ton)	Strok (mm)	Rakor	45 (mm)	60 (mm)	75 (mm)	90 (mm)	105 (mm)	125 (mm)	145 (mm)	170 (mm)
FHR-200	2	43	2	750	5/8	*	*	*					
FHR-201	2	50	2	890	5/8	*	*	*					
FHR-202	2	64	5	920	5/8			*	*	*			
FHR-203	2	74	5	1120	5/8			*	*	*			
FHR-204	2	80	5	1240	5/8			*	*	*			
FHR-205	2	90	5	1440	5/8			*	*	*			
FHR-206	2	100	5	1640	5/8			*	*	*			
FHR-300	3	64	5	1380	5/8		*	*	*	*			
FHR-301	3	74	5	1680	5/8		*	*	*	*			
FHR-302	3	80	5	1860	5/8		*	*	*	*			
FHR-303	3	90	5	2160	5/8		*	*	*	*			
FHR-304	3	100	5	2460	5/8			*	*	*			
FHR-305	3	64	10	1380	3/4				*	*	*		
FHR-306	3	74	10	1680	3/4			*	*	*	*		
FHR-307	3	80	10	1860	3/4			*	*	*	*		
FHR-308	3	85	10	2010	3/4			*	*	*	*		
FHR-309	3	90	10	2160	3/4			*	*	*	*		
FHR-310	3	100	10	2460	3/4			*	*	*	*		
FHR-311	3	64	15	1380	3/4				*	*	*	*	
FHR-312	3	74	15	1680	3/4				*	*	*	*	
FHR-313	3	80	15	1860	3/4				*	*	*	*	
FHR-314	3	85	15	2010	3/4				*	*	*	*	
FHR-315	3	90	15	2160	3/4				*	*	*	*	
FHR-316	3	100	15	2460	3/4				*	*	*	*	



A
model



B
model

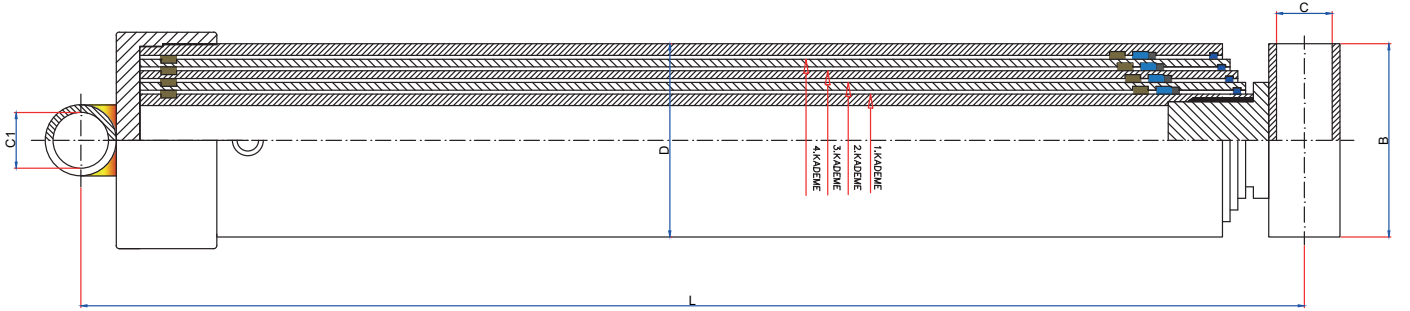

TEKNİK ÖZELLİKLER

Stok Kodu	Kademe	Kapalı Merkez L - (cm)	Kapasite (Ton)	Strok (mm)	Rakor	45 (mm)	60 (mm)	75 (mm)	90 (mm)	105 (mm)	125 (mm)	145 (mm)	170 (mm)
FHR-400	4	64	10	1855	3/4		*	*	*	*	*		
FHR-401	4	74	10	2255	3/4		*	*	*	*	*		
FHR-402	4	80	10	2495	3/4		*	*	*	*	*		
FHR-403	4	85	10	2695	3/4		*	*	*	*	*		
FHR-404	4	90	10	2895	3/4		*	*	*	*	*		
FHR-405	4	100	10	3295	3/4			*	*	*	*	*	
FHR-406	4	64	15	1855	3/4			*	*	*	*	*	
FHR-407	4	74	15	2255	3/4			*	*	*	*	*	
FHR-408	4	80	15	2495	3/4			*	*	*	*	*	
FHR-409	4	85	15	2695	3/4			*	*	*	*	*	
FHR-410	4	90	15	2869	3/4			*	*	*	*	*	
FHR-411	4	100	15	3295	3/4			*	*	*	*	*	*
FHR-412	4	64	20	1855	3/4				*	*	*	*	*
FHR-413	4	74	20	2255	3/4				*	*	*	*	*
FHR-414	4	80	20	2495	3/4				*	*	*	*	*
FHR-415	4	85	20	2695	3/4				*	*	*	*	*
FHR-416	4	90	20	2895	3/4				*	*	*	*	*
FHR-417	4	100	20	3295	3/4				*	*	*	*	*



A
model

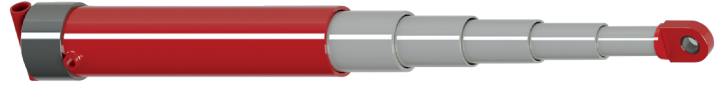

B
model

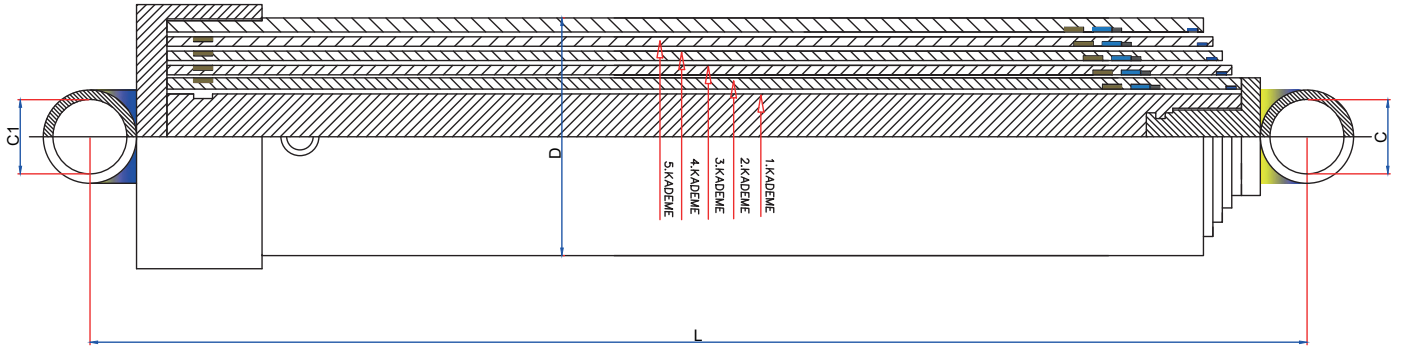

TEKNİK ÖZELLİKLER

Stok Kodu	Kademe	Kapalı Merkez L - (cm)	Kapasite (Ton)	Strok (mm)	Rakor	45 (mm)	60 (mm)	75 (mm)	90 (mm)	105 (mm)	125 (mm)	145 (mm)	170 (mm)
FHR-500	5	64	10	2310	3/4	*	*	*	*	*	*		
FHR-501	5	74	10	2810	3/4	*	*	*	*	*	*		
FHR-502	5	80	10	3110	3/4	*	*	*	*	*	*		
FHR-503	5	85	10	3360	3/4	*	*	*	*	*	*		
FHR-504	5	90	10	3610	3/4	*	*	*	*	*	*		
FHR-505	5	100	10	4110	3/4	*	*	*	*	*	*		
FHR-506	5	64	15	2310	3/4		*	*	*	*	*	*	
FHR-507	5	74	15	2810	3/4		*	*	*	*	*	*	
FHR-508	5	80	15	3110	3/4		*	*	*	*	*	*	
FHR-509	5	85	15	3360	3/4		*	*	*	*	*	*	
FHR-510	5	90	15	3610	3/4		*	*	*	*	*	*	
FHR-511	5	100	15	4110	3/4		*	*	*	*	*	*	
FHR-512	5	64	20	2310	3/4			*	*	*	*	*	*
FHR-513	5	74	20	2810	3/4			*	*	*	*	*	*
FHR-514	5	80	20	3110	3/4			*	*	*	*	*	*
FHR-515	5	85	20	3360	3/4			*	*	*	*	*	*
FHR-516	5	90	20	3610	3/4			*	*	*	*	*	*
FHR-517	5	100	20	4110	3/4			*	*	*	*	*	*

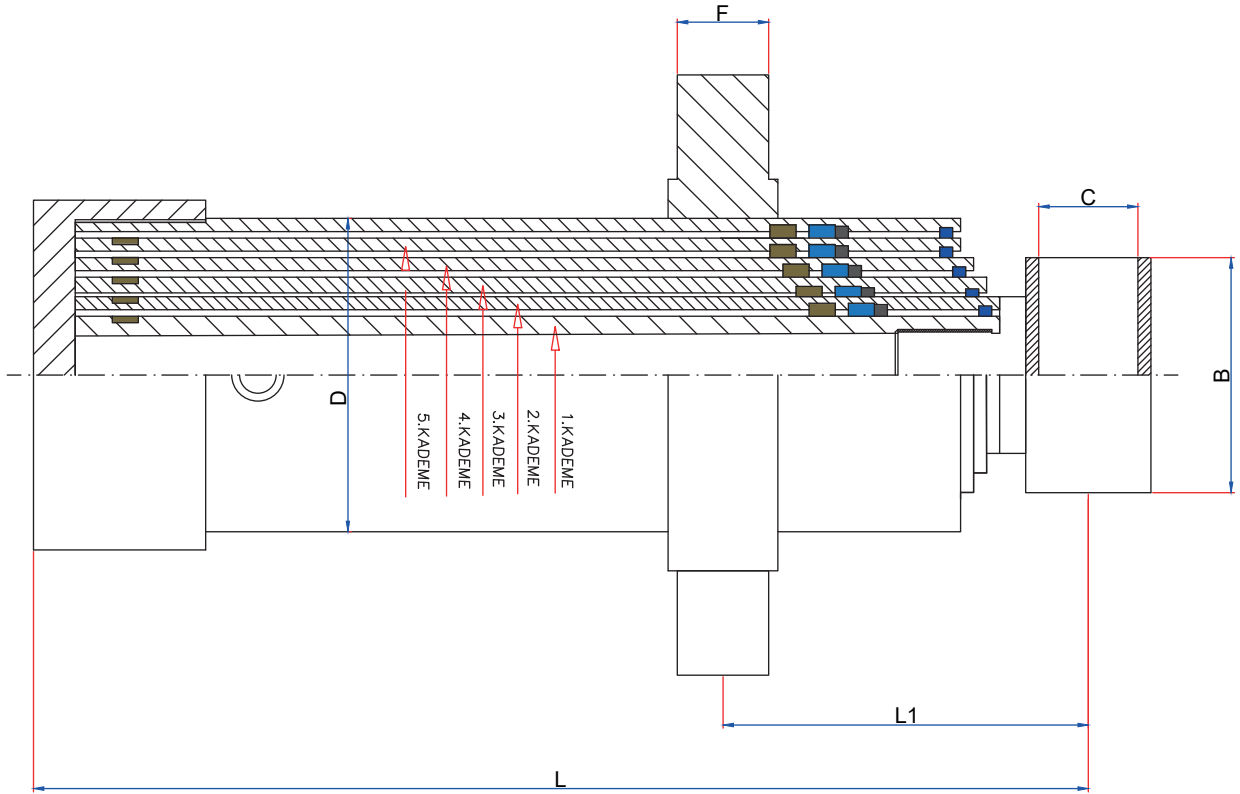
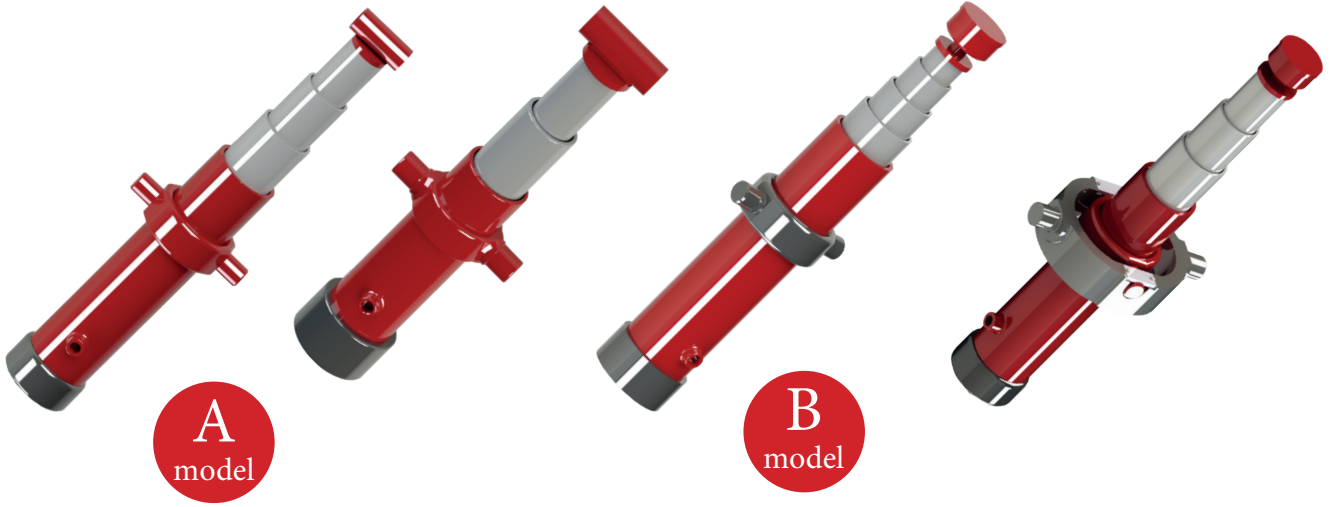

TEKNİK ÖZELLİKLER

Stok Kodu	Kademe	Kapalı Merkez L - (cm)	Kapasite (Ton)	Strok (mm)	Rakor	45 (mm)	60 (mm)	75 (mm)	90 (mm)	105 (mm)	125 (mm)	145 (mm)	170 (mm)
FHR-207	2	38	3	465	5/8		*	*	*				
FHR-208	2	38	5	465	5/8			*	*	*			
FHR317	3	64	10	1380	3/4			*	*	*	*		
FHR-318	3	64	15	1380	3/4				*	*	*	*	
FHR-418	4	64	10	1855	3/4		*	*	*	*	*		
FHR-419	4	64	15	1855	3/4			*	*	*	*	*	
FHR-518	5	64	10	2310	3/4	*	*	*	*	*	*		
FHR-519	5	64	15	2310	3/4		*	*	*	*	*	*	

TEKNİK ÖZELLİKLER				
Stok Kodu	Kademe	Kapalı Merkez L - (cm)	Kapasite (Ton)	Rakor (R)
FHR-7000	2	64	5	5/8
FHR-7001	2	74	5	5/8
FHR-7003	3	64 DAR	5	5/8
FHR-7004	3	74 DAR	5	5/8
FHR-7005	3	64 GENİŞ	10	3/4
FHR-7006	3	80 GENİŞ	10	3/4
FHR-7007	4	64 GENİŞ	10	3/4
FHR-7008	4	80 GENİŞ	10	3/4
FHR-7009	3	64 GENİŞ MAFSALLI	10	3/4
FHR-7010	4	64 GENİŞ MAFSALLI	10	3/4
FHR-7011	2	SAĞ SOL DEVİRMELİ	5	5/8

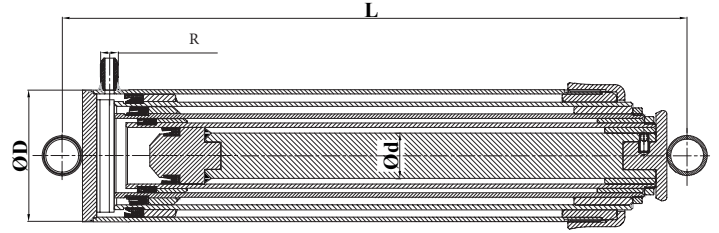

TEKNİK ÖZELLİKLER	
Stok Kodu	Ürün Cinsi
FHR-523	TELEKOPIK RÖMORK LİFTİ TAMİR TAKIMI



TEKNİK ÖZELLİKLER		
Stok Kodu	Kademe	Kapalı Merkez L - (cm)
FHR-7200	2	KEÇE
FHR-7201	3	KEÇE DAR
FHR-7202	3	KEÇE GENİŞ
FHR-7203	4	KEÇE GENİŞ

TELESKOPIK SİLİNDİR



FHR-520

TELESKOPIK SİLİNDİR

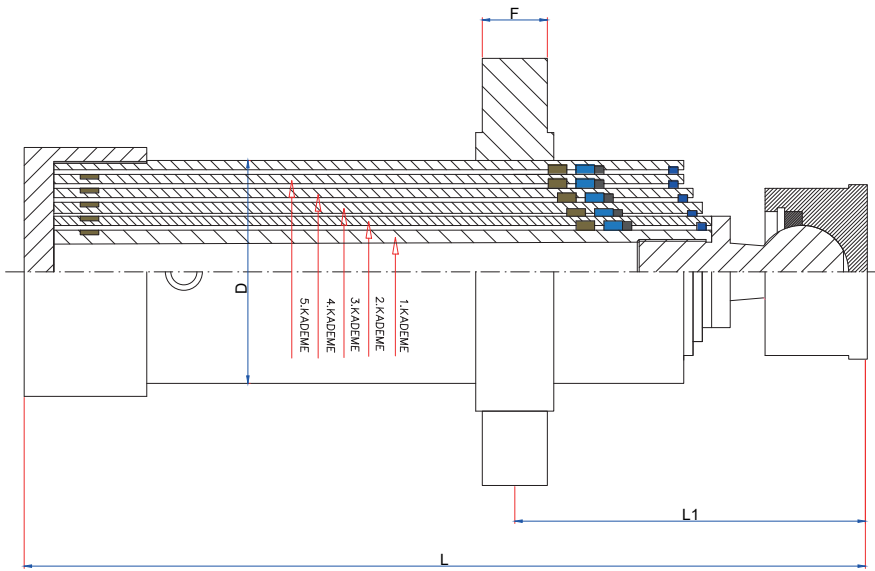
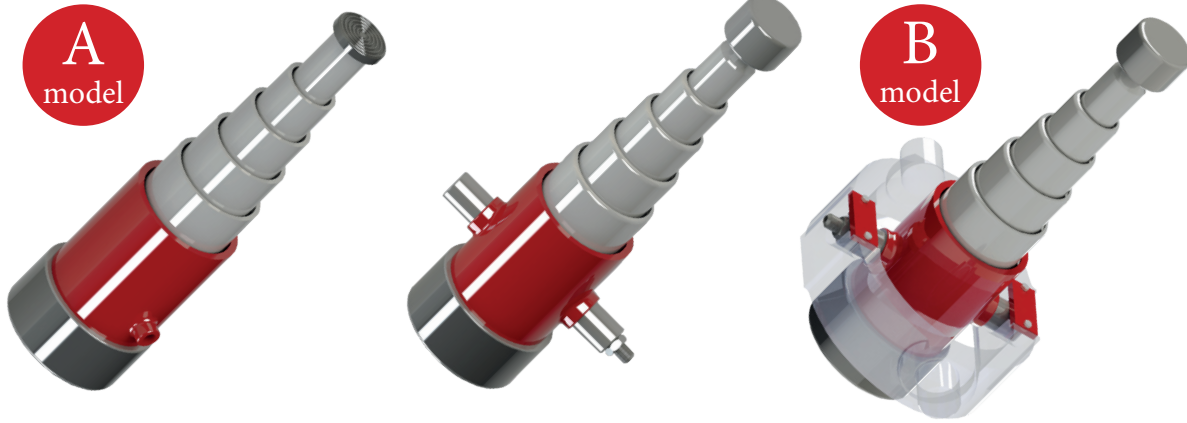

TEKNİK ÖZELLİKLER

Stok Kodu	Ürün Cinsi	Kademe	Kapalı Merkez L - (cm)	Kapasite (Ton)	Strok (mm)	Rakor	45 (mm)	60 (mm)	75 (mm)	90 (mm)	105 (mm)	125 (mm)
FHR-520	3 YANA DEVİRME	5	245	10	450	3/4	*	*	*	*	*	*
FHR-521	KRIKO	5	310	10	450	3/4	*	*	*	*	*	*

FHR-319

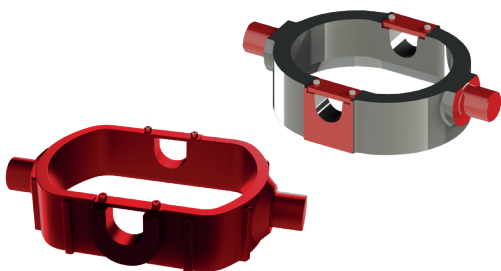

TEKNİK ÖZELLİKLER

Stok Kodu	Ürün Cinsi	Kademe
FHR-319	3 YANA DEVİRME MAFSALI	5
FHR-420	3 YANA DEVİRME MAFSALI	10
FHR-522	3 YANA DEVİRME MAFSALI	15
FHR-732	ORTA KOL MAFSALI	7,5

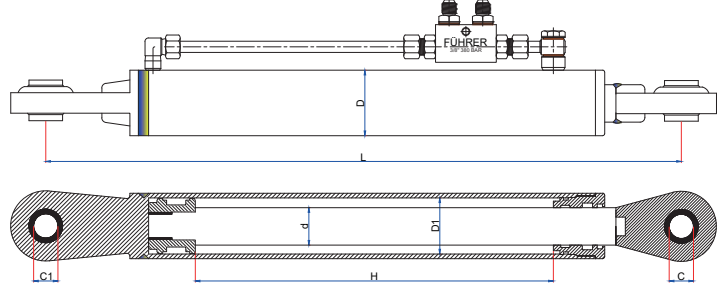
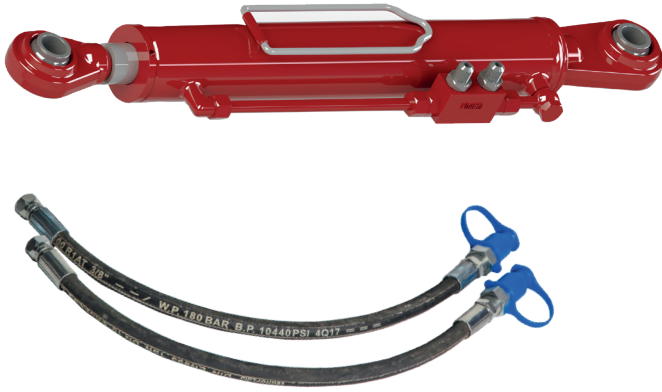

TEKNİK ÖZELLİKLER

Stok Kodu	Ürün Cinsi	Kapasite (Ton)	Kapalı Merkez L - (cm)	Strok H-(mm)	Pim Çapı C1-C (mm)	Tip	Dış Çapı D1-D (mm)	Mil Çapı d - (mm)
FHR-600	ORTAKOL LİFTİ	2	50	200	26*26-GG		60*70	40
FHR-601	ORTAKOL LİFTİ	2	55	250	26*26-GG		60*70	40
FHR-602	ORTAKOL LİFTİ	2	60	300	26*26-GG		60*70	40
FHR-603	ORTAKOL LİFTİ	2	68	370	26*26-GG		60*70	40
FHR-604	ORTAKOL LİFTİ	2	50	200	19*26-DG		60*70	40
FHR-605	ORTAKOL LİFTİ	2	55	250	19*26-DG		60*70	40
FHR-606	ORTAKOL LİFTİ	2	60	300	19*26-DG		60*70	40
FHR-607	ORTAKOL LİFTİ	2	68	370	19*26-DG		60*70	40
FHR-608	ORTAKOL LİFTİ	2	50	200	26*26-GG	DİK	60*70	40
FHR-609	ORTAKOL LİFTİ	2	55	250	26*26-GG	DİK	60*70	40
FHR-610	ORTAKOL LİFTİ	2	60	300	26*26-GG	DİK	60*70	40
FHR-611	ORTAKOL LİFTİ	2	68	370	26*26-GG	DİK	60*70	40
FHR-612	ORTAKOL LİFTİ	2	50	200	19*26-DG	DİK	60*70	40
FHR-613	ORTAKOL LİFTİ	2	55	250	19*26-DG	DİK	60*70	40
FHR-614	ORTAKOL LİFTİ	2	60	300	19*26-DG	DİK	60*70	40
FHR-615	ORTAKOL LİFTİ	2	68	370	19*26-DG	DİK	60*70	40
FHR-616	ORTAKOL LİFTİ	3	50	200	26*26-GG		63*75	40
FHR-617	ORTAKOL LİFTİ	3	55	250	26*26-GG		63*75	40
FHR-618	ORTAKOL LİFTİ	3	60	300	26*26-GG		63*75	40
FHR-619	ORTAKOL LİFTİ	3	68	370	19*26-DG		63*75	40
FHR-620	ORTAKOL LİFTİ	3	50	200	19*26-DG		63*75	40
FHR-621	ORTAKOL LİFTİ	3	55	250	19*26-DG		63*75	40
FHR-622	ORTAKOL LİFTİ	3	60	300	19*26-DG		63*75	40
FHR-623	ORTAKOL LİFTİ	3	68	370	19*26-DG		63*75	40
FHR-624	ORTAKOL LİFTİ	3	50	200	26*26-GG	DİK	63*75	40
FHR-625	ORTAKOL LİFTİ	3	55	250	26*26-GG	DİK	63*75	40
FHR-626	ORTAKOL LİFTİ	3	60	300	26*26-GG	DİK	63*75	40
FHR-627	ORTAKOL LİFTİ	3	68	370	26*26-GG	DİK	63*75	40
FHR-628	ORTAKOL LİFTİ	3	50	200	19*26-DG	DİK	63*75	40
FHR-629	ORTAKOL LİFTİ	3	55	250	19*26-DG	DİK	63*75	40
FHR-630	ORTAKOL LİFTİ	3	60	300	19*26-DG	DİK	63*75	40
FHR-631	ORTAKOL LİFTİ	3	68	370	19*26-DG	DİK	63*75	40



TEKNİK ÖZELLİKLER

Stok Kodu	Ürün Cinsi	Kapasite (Ton)	Kapalı Merkez L - (cm)	Strok H-(mm)	Pim Çapı C1-C (mm)	Tip	Dış Çapı D1-D (mm)	Mil Çapı d - (mm)
FHR-700	ORTAKOL LİFTİ	5	50	185	26*26-GG		70*80	45
FHR-701	ORTAKOL LİFTİ	5	55	235	26*26-GG		70*80	45
FHR-702	ORTAKOL LİFTİ	5	60	285	26*26-GG		70*80	45
FHR-703	ORTAKOL LİFTİ	5	68	355	26*26-GG		70*80	45
FHR-704	ORTAKOL LİFTİ	5	50	185	19*26-DG		70*80	45
FHR-705	ORTAKOL LİFTİ	5	55	235	19*26-DG		70*80	45
FHR-706	ORTAKOL LİFTİ	5	60	285	19*26-DG		70*80	45
FHR-707	ORTAKOL LİFTİ	5	68	355	19*26-DG		70*80	45
FHR-708	ORTAKOL LİFTİ	5	50	185	26*26-GG	DİK	70*80	45
FHR-709	ORTAKOL LİFTİ	5	55	235	26*26-GG	DİK	70*80	45
FHR-710	ORTAKOL LİFTİ	5	60	285	26*26-GG	DİK	70*80	45
FHR-711	ORTAKOL LİFTİ	5	68	355	26*26-GG	DİK	70*80	45
FHR-712	ORTAKOL LİFTİ	5	50	185	19*26-DG	DİK	70*80	45
FHR-713	ORTAKOL LİFTİ	5	55	235	19*26-DG	DİK	70*80	45
FHR-714	ORTAKOL LİFTİ	5	60	385	19*26-DG	DİK	70*80	45
FHR-715	ORTAKOL LİFTİ	5	68	355	19*26-DG	DİK	70*80	45
FHR-716	ORTAKOL LİFTİ	2	50	250	26*26-GG	C.KAFA	60*70	40
FHR-717	ORTAKOL LİFTİ	2	55	300	26*26-GG	C.KAFA	60*70	40
FHR-718	ORTAKOL LİFTİ	2	60	350	26*26-GG	C.KAFA	60*70	40
FHR-719	ORTAKOL LİFTİ	2	68	370	26*26-GG	C.KAFA	60*70	40
FHR-720	ORTAKOL LİFTİ	3	50	250	26*26-GG	C.KAFA	60*70	40
FHR-721	ORTAKOL LİFTİ	3	55	300	26*26-GG	C.KAFA	60*70	40
FHR-722	ORTAKOL LİFTİ	3	60	350	26*26-GG	C.KAFA	60*70	40
FHR-723	ORTAKOL LİFTİ	3	68	370	26*26-GG	C.KAFA	60*70	40
FHR-724	ORTAKOL LİFTİ	5	50	185	26*26-GG	C.KAFA	70*80	45
FHR-725	ORTAKOL LİFTİ	5	55	235	26*26-GG	C.KAFA	70*80	45
FHR-726	ORTAKOL LİFTİ	5	60	285	26*26-GG	C.KAFA	70*80	45
FHR-727	ORTAKOL LİFTİ	5	68	355	26*26-GG	C.KAFA	70*80	45
FHR-728	ORTAKOL LİFTİ	7,5 CAT2	50	180	26*26-GG	C.KAFA MAFSALLI	90*105	50
FHR-729	ORTAKOL LİFTİ	7,5 CAT2	55	230	26*26-GG	C.KAFA MAFSALLI	90*105	50
FHR-730	ORTAKOL LİFTİ	7,5 CAT2	60	280	26*26-GG	C.KAFA MAFSALLI	90*105	50
FHR-731	ORTAKOL LİFTİ	7,5 CAT2	68	350	26*26-GG	C.KAFA MAFSALLI	90*105	50
FHR-732	ORTAKOL LİFTİ	7,5 CAT3	50	180	26*26-GG	C.KAFA MAFSALLI	90*105	50
FHR-733	ORTAKOL LİFTİ	7,5 CAT3	55	230	26*26-GG	C.KAFA MAFSALLI	90*105	50
FHR-734	ORTAKOL LİFTİ	7,5 CAT3	60	280	26*26-GG	C.KAFA MAFSALLI	90*105	50
FHR-735	ORTAKOL LİFTİ	7,5 CAT3	68	350	26*26-GG	C.KAFA MAFSALLI	90*105	50

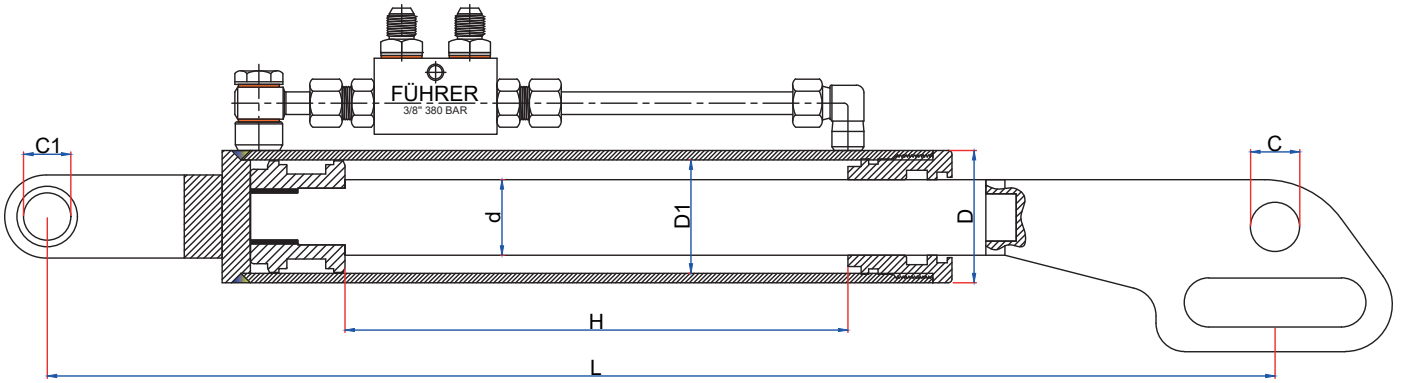
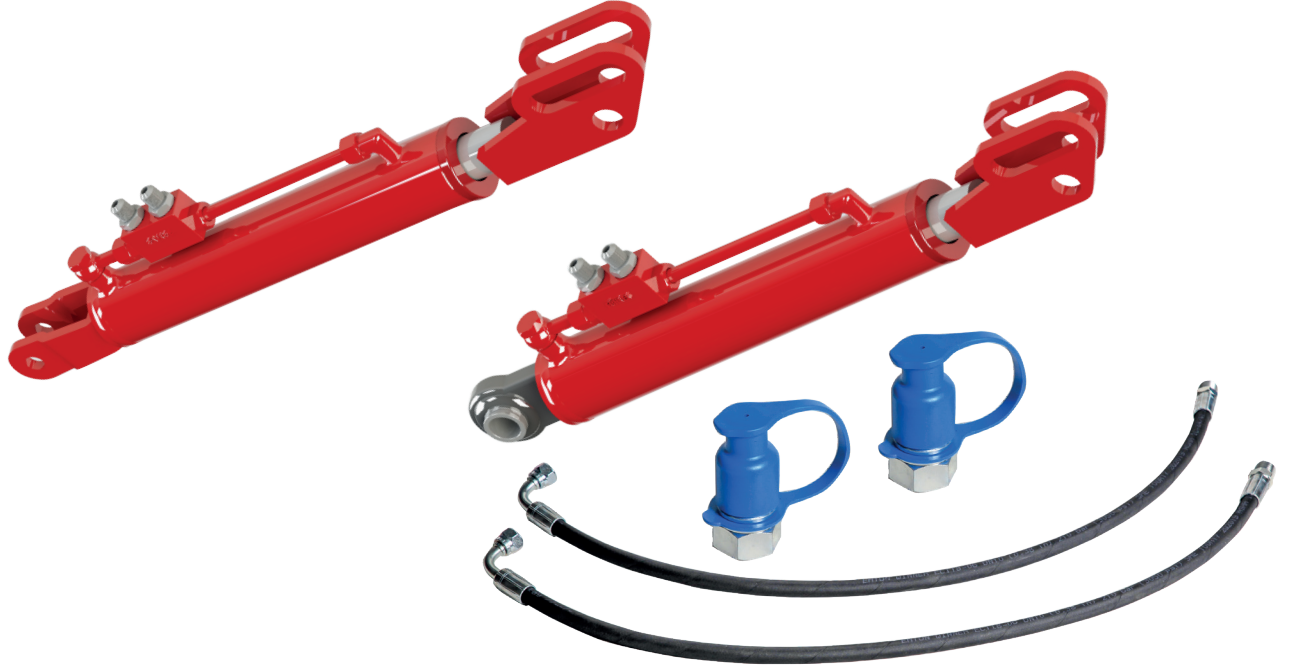

TEKNİK ÖZELLİKLER

Stok Kodu	Ürün Cinsi	Kapasite (Ton)	Kapalı Merkez L-(cm)	Strok H-(mm)	Pim Çapı C1-C-(mm)	Boru Çapı D1-D-(mm)	Mil Çapı d-(mm)
FHR-800	DİK AYARLI KOL LİFTİ	2	45	100	19*26	60*70	40
FHR-801	DİK AYARLI KOL LİFTİ	2	50	150	19*26	60*70	40
FHR-802	DİK AYARLI KOL LİFTİ	2	55	200	19*26	60*70	40
FHR-803	DİK AYARLI KOL LİFTİ	2	60	250	19*26	60*70	40
FHR-804	DİK AYARLI KOL LİFTİ	2	65	300	19*26	60*70	40
FHR-805	DİK AYARLI KOL LİFTİ	2	70	350	19*26	60*70	40
FHR-806	DİK AYARLI KOL LİFTİ	2	45	100	23*26	60*70	40
FHR-807	DİK AYARLI KOL LİFTİ	2	50	150	23*26	60*70	40
FHR-808	DİK AYARLI KOL LİFTİ	2	55	200	23*26	60*70	40
FHR-809	DİK AYARLI KOL LİFTİ	2	60	250	23*26	60*70	40
FHR-810	DİK AYARLI KOL LİFTİ	2	65	300	23*26	60*70	40
FHR-811	DİK AYARLI KOL LİFTİ	2	70	350	23*26	60*70	40

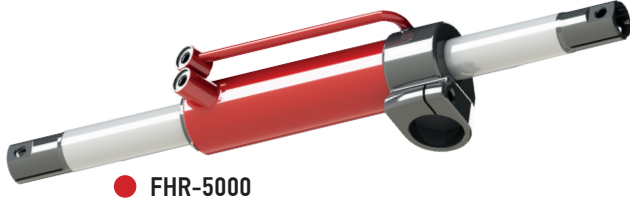

● FHR-5000



● FHR-5001



● FHR-5002



● FHR-5003

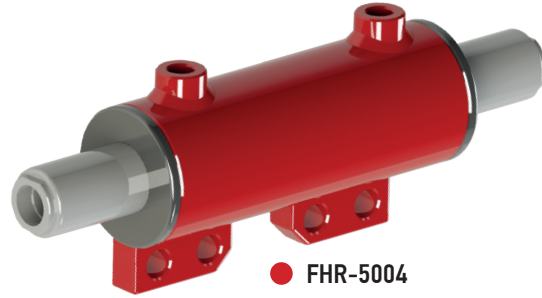

● FHR-5004

TEKNİK ÖZELLİKLER

Stok Kodu	Ürün Cinsi	Oem Kodu	Marka	Model
FHR-5000	HİDROLİK DİREKSİYON SİLİNDİRİ	"3773713M91 3763762M91 6202491M91"	MASSEY FERGUSON	"375, 383, 390T, 393, 398, 399"
FHR-5001	HİDROLİK DİREKSİYON SİLİNDİRİ	-	MASSEY FERGUSON	-
FHR-5002	T FREN MERKEZİ (KALIN DELİK)	84247064	FIAT	"TD65D- TD75D"
FHR-5003	T FREN MERKEZİ (İNCE DELİK)	87748455	FIAT	"TD5.110- TD5.90"
FHR-5004	HİDROLİK DİREKSİYON SİLİNDİRİ	0013901U91	MASSEY FERGUSON	"240- 260"

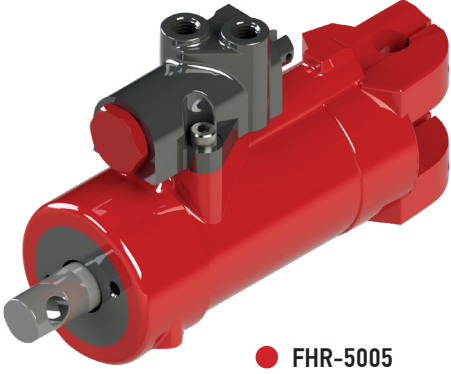

● FHR-5005

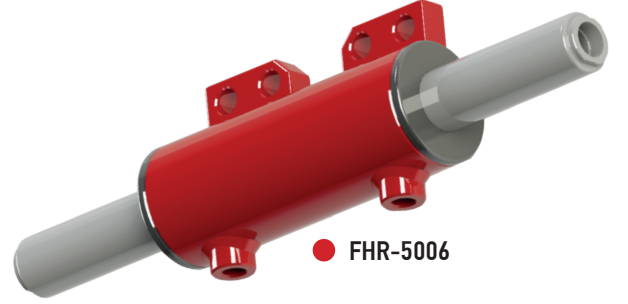

● FHR-5006

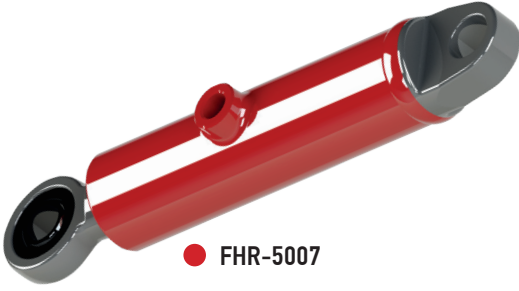

● FHR-5007

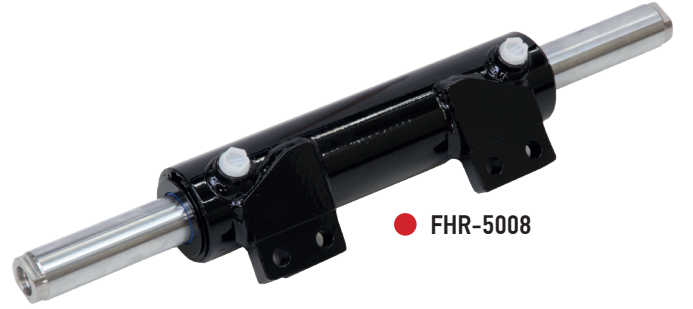

● FHR-5008



● FHR-5009

TEKNİK ÖZELLİKLER

Stok Kodu	Ürün Cinsi	Oem Kodu	Marka	Model
FHR-5005	ÖN DİREKSİYON SİLİNDİRİ	1853466M93, 1884374M93,3186323M91, 3773740M91,1830316M91, 1853195M92, 1853466M91, 1884374M91, 1885579M91,3186320M91, 3186320M92, 505525M91	MASSEY FERGUSON	"165, 168, 175, 175S, 178 185, 188, 265, 275, 285, 290 375, 390"
FHR-5006	"HİD.DİREKSİYON SİLİNDİR MİLİ 10 CM UZUN"	0013901U91	MASSEY FERGUSON	240-260
FHR-5007	"DESTEK SİLİNDİRİ (HORTUM-RAKOR-PİM)"	84520524	CASE IH	"65C- 75C"
FHR-5008	HİDROLİK DİREKSİYON SİLİNDİRİ	7182640001	BAŞAK	-
FHR-5009	HİDROLİK ORTAKOL	-	BAŞAK	-



● FHR-5010



● FHR-5012 - PARALEL

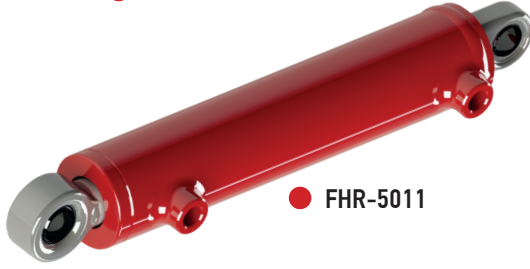

● FHR-5011



● FHR-5012 - ÇAPRAZ



● FHR-5013



● FHR-5014

TEKNİK ÖZELLİKLER

Stok Kodu	Ürün Cinsi	Oem Kodu	Marka	Model
FHR-5010	HİDROLİK DİREKSİYON SİLİNDİRİ	5088311	FİAT	54C-TT
FHR-5011	HİDROLİK DİREKSİYON SİLİNDİRİ	5083321	FİAT	80-66DT
FHR-5012	"HİDROLİK DİREKSİYON SİLİNDİRİ (ROTLU)" ÇAPRAZ RAKORLU - PARALEL RAKORLU	5093753, 5173145, 5113130, 67639, 5098112 - 5113093 - 5123968 - 5125260 - 5123022-5143022- 5189897 - 5140638	FİAT	6056 - 7056 - 45 - 66 - 80 - 66 - 100 - 110 - 55 - 65 - 446 - 466 - 566 - 666 - 766 - 580 - 680 - 780 - 880 - 880/5 - 980 - 55/46 - 55/66 - 60/66 - 65/46 - 65/66 - 70/66 - 80/66 - 55/90 - 60/90 - 65/90 - 70/90 - 80/90 - 85/90 - 90/90 - 100/90 - 110/90 - 60/93 - 60/94 - 6293 - 62/94 - 72/93 - 72/94 - 82/93 - 82/94
FHR-5013	ÖN DİREKSİYON BEYİNCİĞİ	11407	MASSEY FERGUSON	165 - 185 - 275- 285 - 290
FHR-5014	ÖN DİREKSİYON SİLİNDİRİ BE-YİNSİZ	532193M91 - 1605121M92 - 3773711M91	MASSEY FERGUSON	"255- 265- 270-275- 285-290"

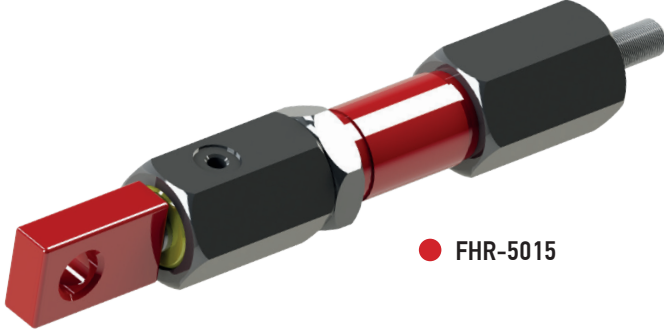

● FHR-5015

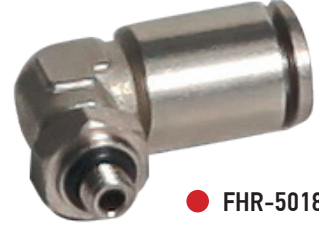

● FHR-5018

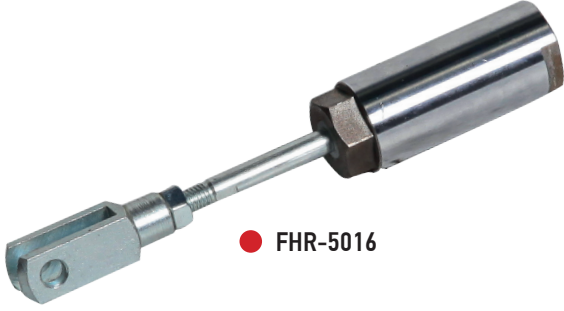

● FHR-5016



● FHR-5019



● FHR-5017

TEKNİK ÖZELLİKLER

Stok Kodu	Ürün Cinsi	Oem Kodu	Marka	Model
FHR-5015	AUTO LİFT SİLİNDİRİ	0017100U91	MASSEY FERGUSON	-
FHR-5016	"AUTO SİLİNDİR DIŞ ÇATAL MEKANİZMASI"	0016658U91	MASSEY FERGUSON	277-3050-3105
FHR-5017	"AUTO SİLİNDİR MEKANİZMASI (HORTUMU)"	17096	MASSEY FERGUSON	-
FHR-5018	"AUTO SİLİNDİR MEKANİZMASI (ÇELİK DİRSEK)"	17097	MASSEY FERGUSON	-
FHR-5019	"AUTO SİLİNDİR MEKANİZMASI (DÜZ RAKOR)"	17098	MASSEY FERGUSON	-

● FHR-5020



● FHR-5021



● FHR-5022

● FHR-5023



● FHR-5024

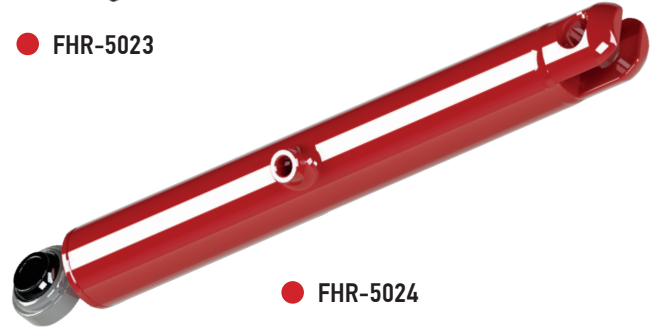

TEKNİK ÖZELLİKLER

Stok Kodu	Ürün Cinsi	Oem Kodu	Marka	Model
FHR-5020	"HİDROLİK DİREKSİYON AMORTİSÖRÜ (SAĞ-SOL)"	3401553M92-3774728V91-3774728M91-3773716M91-3443036M91	MASSEY FERGUSON	"231, 240, 240EF.-255 EP-260 250, 253, 360, 362, 20D, 30E, 40E "
FHR-5021	"HİDROLİK DİREKSİYON AMORTİSÖRÜ (SOL)"	3401241M91RH, 0011404U913401240M91, 0011403U91, 1674492M92, 001403U91, 1662946M92, 1673086M91, 1674491M92	MASSEY FERGUSON	"20 - 202 - 203 - 205- 2135 - 230 - 240 - 240S - 245 - 250 - 255 - 260 - 550 - 560"
FHR-5022	"HİDROLİK DİREKSİYON AMORTİSÖRÜ (SAĞ)"	"3401241M91, 0011404U91"	MASSEY FERGUSON	20, 202, 203, 205, 2135
FHR-5023	HİDROLİK DİREKSİYON SİLİNDİRİ	"3429989M91- 00112130U1"	MASSEY FERGUSON	265, 275, 285, 290, 365, 375, 390, 396, 398, 399, 4225, 4235, 4240, 4245, 4255, 4260, 4265, 4270, 4325, 4335, 4345, 4355, 4360, 4365, 4370, 5425, 5435, 5445, 5455, 6610, 6120, 5445, 5435, 6130, 6140, 6235, 6245, 6255
FHR-5024	DESTEK SİLİNDİRİ (SAĞ)	"1749276M91- 3773709M91"	MASSEY FERGUSON	200 - 300 - 3000 SERİLERİ

● FHR-5025



● FHR-5028



● FHR-5026



● FHR-5027



● FHR-5029



TEKNİK ÖZELLİKLER

Stok Kodu	Ürün Cinsi	Oem Kodu	Marka	Model
FHR-5025	DESTEK SİLİNDİRİ (SOL)	"3773710M91-1748456M92"	MASSEY FERGUSON	200 - 300 - 3000 SERİLERİ
FHR-5026	HİDROLİK DİREKSİYON SİLİNDİRİ	7256522	TÜMOSAN	4X4
FHR-5027	HİDROLİK DİREKSİYON SİLİNDİRİ	7255837	TÜMOSAN	4x2
FHR-5028	"HİDROLİK DİREKSİYON SİLİNDİRİ (ROTLU)"	7253799	TÜMOSAN	74,80N- 82,80N
FHR-5029	HİDROLİK DİREKSİYON SİLİNDİRİ	"5189895-5142046-5173144"	FIAT	F100DT, C3394, F110DT, C3394, F110DT, 45-66, D3041, 50-66, D3041, 55-56DT, 55-66DT, D3104, 60-56DT, D4628, 60-66, D3104, 60-90DT, D3104, 60-93DT, 60-94DT, 65-90DT, D3041-3104, 65-93DT, 65-94DT, 70-66SDT, D4628, 70-90DT, D3104, 80-90DT, D3104, 85-90DT, 90-90DT, D3104, 100-90DT, 110-90DT, TD60D, TD70D, TD75D, TD80D, TD85D, TD90D, TD95D, TD5010, TD5020, TD5030, TD5050, TT60A, TT75A, 5530, 6530

● FHR-5030



● FHR-5031



● FHR-5033



● FHR-5032



● FHR-5034



TEKNİK ÖZELLİKLER

Stok Kodu	Ürün Cinsi	Oem Kodu	Marka	Model
FHR-5030	HİDROLİK DİREKSİYON LİFTİ	716264001	BAŞAK	-
FHR-5031	"HİDROLİK DİREKSİYON SİLİNDİRİ (ÇAPRAZ)"	5142046 -5156717 -84191439- 84191439 - 5142052 - 5142054 - 5143971 - 5156717	FİAT	"980DT, 4566DT, 5546DT, 7056DT, 8066DT, 110.90, DT-115.90, DT-130.90, DT-140.90,DT-100-90, 55-90, 60-90, 65-90, 70-90, 80-90, 85-90, 90-90"
FHR-5032	DESTEK SİLİNDİRİ	47839306	FİAT	TT4.55
FHR-5033	DESTEK SİLİNDİRİ	5200740097	BAŞAK	-
FHR-5034	HİDROLİK DİREKSİYON SİLİNDİRİ	188842A1	CASE IH	"238-248-258-268- 288-3210-3220-3230- 385- 395-395 XL-4210- 4220-4230-4240-454- 474- 475-484-485-485 XL-495-495 XL-574- 584-585- 585 XL-595-595 XL-674-684-685-685 XL-695-695 XL-784-785-785 XL-795-884-885-885 XL-895-895 XL-995 XL-CX100- CX50-CX60-CX70- CX80-CX90-Hydro 84-Hydro 85-MX100 C-MX80 C-MX90 C"



● FHR-5038



● FHR-5035



● FHR-5039

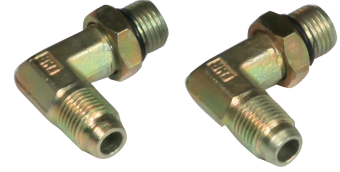

● FHR-5036



● FHR-5037

TEKNİK ÖZELLİKLER

Stok Kodu	Ürün Cinsi	Oem Kodu	Marka	Model
FHR-5035	DESTEK SİLİNDİRİ	E080017331251	ERKUNT	ZF
FHR-5036	GÜÇ DİREKSİYON POMPASI DİRSEK	357197X1	MASSEY FERGUSON	"165-168- 175-178-185- 188-265- 275-285-290"
FHR-5037	FREN ANA PİSTONU	87748269	FİAT	JX80 TIERII/JXU 105/ JXU 95/JXU 85/JX95 TIERII/JX90 TIERII/ JX55/JX75/JX70 TIERII/JX90_C_4/ JX90_C_2/JX60 TIERII/ JX60/JX70/JX80/ JX55E/JX60E/JX75 TIER 3/JX100 TIER 3/ JX75E/JX90 TIER 3/ JX80E/JX80 TIER 3/ JX70 TIER 3
FHR-5038	DİREKSİYON SİLİNDİRİ	3483329M92	MASSEY FERGUSON	"340-350-355-360- 362-365-375-390- 390T"
FHR-5039	DİREKSİYON SİLİNDİRİ	3765190M91	MASSEY FERGUSON	"2205-2210- 2225-2235"

● FHR-5040



● FHR-5042



● FHR-5043



● FHR-5041



● FHR-5044



TEKNİK ÖZELLİKLER

Stok Kodu	Ürün Cinsi	Oem Kodu	Marka	Model
FHR-5040	HİDROLİK DİREKSİYON SİLİNDİRİ	5198883	FİAT	T7030, T7040, T7050, T7060, T7070, T7.220, T7.230, T7.235, T7.245, T7.250, T7.260, T7.270, T8.275, T8.300, T8.320, T8.350, T8.410, T8.435, TM120, TM130, TM140, TM155, TM175, TM190
FHR-5041	HİDROLİK DİREKSİYON SİLİNDİRİ	"5144126-5134221-5144124-5143970-5156718"	FİAT	F120DT, F130DT, C3394, 70-66DT, D3104, 70-66SDT, 70-88DT, 80-66, D3104, 80-66DT, D3104, 80-88DT, 115-90DT, D3063, 130-90DT, D3063, 140-90DT, 160-90DT, 180-90DT, 90, Farmall 95, JX75, JX80, JX85, JX90, JX95----TD75D, TD80D, TD90D, TD95D, TD5030, TD5050, 5530, 6530
FHR-5042	HİDROLİK DİREKSİYON SİLİNDİRİ	126638-120226	BAŞAK	-
FHR-5043	HİDROLİK DİREKSİYON SİLİNDİRİ	5189995	FİAT	T4040F, T4.100F, T4050F, T4.105F, T4060F, T4.110F, T4.75F, T4.80F, T4.85F, T4.90F, TN65F, TN70F, T4.95F, TN75F, TN80F, TN90F, TN95F, TN75FA, TN85FA, TN95FA, T4030F
FHR-5044	HİDROLİK DESTEK SİLİNDİRİ	-	TÜMOSAN	7000-8000

● FHR-5045



● FHR-5046



● FHR-5048



● FHR-5047

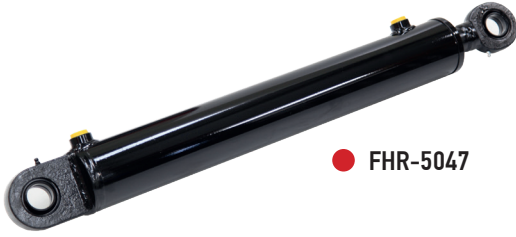

● FHR-5049



TEKNİK ÖZELLİKLER

Stok Kodu	Ürün Cinsi	Oem Kodu	Marka	Model
FHR-5045	HİDROLİK SİLİNDİR GERGİ - HORTUM TAKIMI	-	MASSEY FERGUSON	265-285-266G- 277G-288G-286G- 398-3075- 3085-3095-3105
FHR-5046	HİDROLİK DİREKSİYON SİLİNDİRİ	"5189887 - 5165140 - 5190908 - 5083394"	FİAT	JX70U, MXM120, MXM130, MXM140, MXU100, MXU110, MXU115, MXU125, MXU130, MXU135
FHR-5047	HİDROLİK DİREKSİYON SİLİNDİRİ	5164023	FİAT	"F100DT, D3394, F115DT, 72-93DT, 72-94DT, 82-93DT, 82-94DT, 88-93DT, 88-94DT T5030- 5040-5060-TD80-TD90- TD95-TL70-TL80-TL90- TL100-L75-L85-L95"
FHR-5048	HİDROLİK DİREKSİYON SİLİNDİRİ	103137	ERKUNT	-
FHR-5049	HİDROLİK DİREKSİYON SİLİNDİRİ	109070	ERKUNT	-



● FHR-5050



● FHR-5051



● FHR-5052



● FHR-5053



● FHR-5054

TEKNİK ÖZELLİKLER

Stok Kodu	Ürün Cinsi	Oem Kodu	Marka	Model
FHR-5050	HİDROLİK DİREKSİYON SİLİNDİR ROTU	-	FIAT	70/56
FHR-5051	HİDROLİK KALD. SİLİNDİRİ (SAĞ)	47474755	CASE IH	JX 100-JX 90-JX 80-JX 70
FHR-5052	HİDROLİK KALD. SİLİNDİRİ (SOL)	47474754	CASE IH	"JX 100 - JX 90 - JX 80 - JX 70 - TD95 - TD100 - TD110"
FHR-5053	55/46 HİD. PİSTON ROT DÜZ UÇLU	9960076	FIAT	55-46
FHR-5054	54C HİD. PİSTON ROTU E.M. DÜZ	9962673	FIAT	54C



● FHR-5055



● FHR-5059



● FHR-5056



● FHR-5057



● FHR-5060

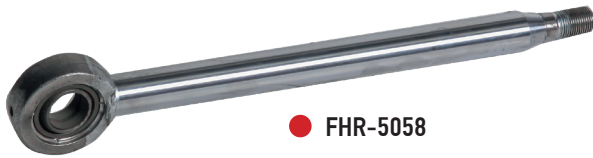

● FHR-5058

TEKNİK ÖZELLİKLER

Stok Kodu	Ürün Cinsi	Oem Kodu	Marka	Model
FHR-5055	REPL ROTBAŞI	8278057400	TÜMOSAN	-
FHR-5056	REPL PİSTON ROTU	5080087	FIAT	54C
FHR-5057	REPL. PİSTON ROTU	5080092	FIAT	80/66DT
FHR-5058	REPL. PİSTON ROTU	9962188	FIAT	80/66
FHR-5059	PTO KONTROL BEYNİ	47901714	FIAT	TD SERİSİ
FHR-5060	DESTEK PİSTONU	47375572	NEW HOLLAND	



FÜHRER





ÖZEL AMAÇLI

LİFTLER



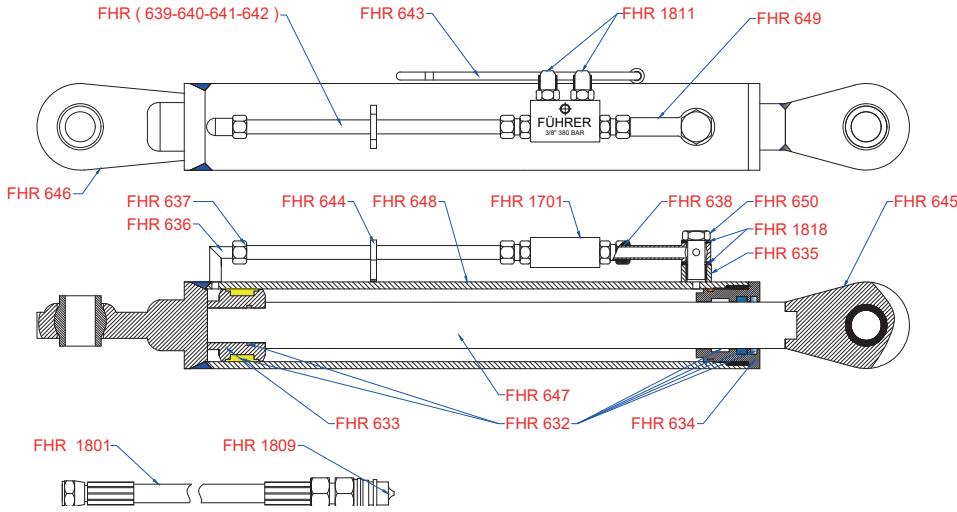

TEKNİK ÖZELLİKLER

Stok Kodu	Ürün Cinsi	Grup	Tip
FHR-632	ORTAKOL LİFTİ TAMİR TAKIMI	HİD. ORTAKOL - HİD.DİK AYARLI KOL	STANDART
FHR-633	ORTAKOL LİFT PİSTONU	HİD. ORTAKOL - HİD.DİK AYARLI KOL	STANDART
FHR-634	ORTAKOL LİFT KEPİ	HİD. ORTAKOL - HİD.DİK AYARLI KOL	STANDART
FHR-635	3/8 KAYNAKLIK MAŞON	HİD. ORTAKOL - HİD.DİK AYARLI KOL	STANDART
FHR-636	M18X1.5 KAYNAKLIK DİRSEK	HİD. ORTAKOL - HİD.DİK AYARLI KOL	STANDART
FHR-637	M18X1.5 SOMUN	HİD. ORTAKOL - HİD.DİK AYARLI KOL	STANDART
FHR-638	12MM YÜSSÜK	HİD. ORTAKOL - HİD.DİK AYARLI KOL	STANDART
FHR-639	12MM TESİSAT BORUSU	HİD. ORTAKOL - HİD.DİK AYARLI KOL	68 CM
FHR-640	12MM TESİSAT BORUSU	HİD. ORTAKOL - HİD.DİK AYARLI KOL	60 CM
FHR-641	12MM TESİSAT BORUSU	HİD. ORTAKOL - HİD.DİK AYARLI KOL	55 CM
FHR-642	12MM TESİSAT BORUSU	HİD. ORTAKOL - HİD.DİK AYARLI KOL	50 CM
FHR-643	ASKI APARATI	HİD. ORTAKOL	STANDART
FHR-644	TESİSAT BORU DESTEĞİ	HİD. ORTAKOL - HİD.DİK AYARLI KOL	STANDART
FHR-645	MİL BAŞLIGI	HİD. ORTAKOL - HİD.DİK AYARLI KOL	STANDART
FHR-646	BORU BAŞLIGI	HİD. ORTAKOL - HİD.DİK AYARLI KOL	STANDART
FHR-647	KROMLU MİL	HİD. ORTAKOL - HİD.DİK AYARLI KOL	STANDART
FHR-648	DIŞ BORU	HİD. ORTAKOL - HİD.DİK AYARLI KOL	STANDART
FHR-649	HALKA REKORU 12X17	HİD. ORTAKOL - HİD.DİK AYARLI KOL	STANDART
FHR-650	CIVATA RAKORU	HİD. ORTAKOL - HİD.DİK AYARLI KOL	STANDART

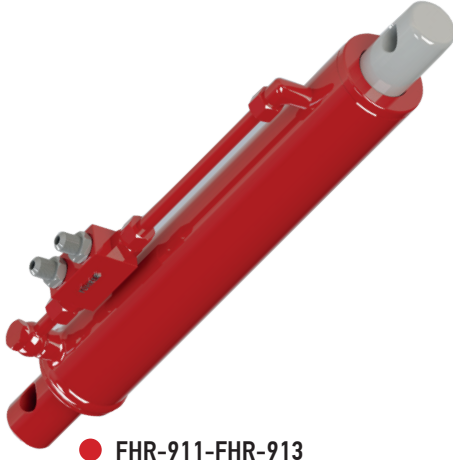

● FHR-911-FHR-913



● FHR-900-FHR-909

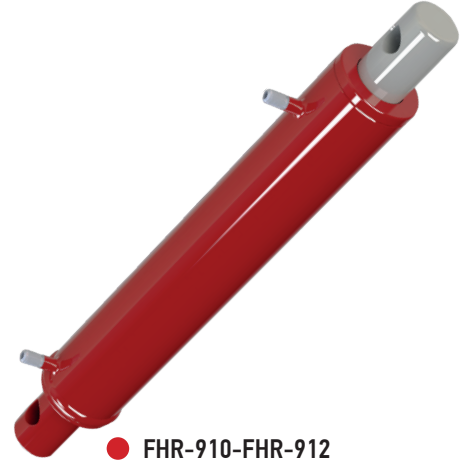

● FHR-910-FHR-912

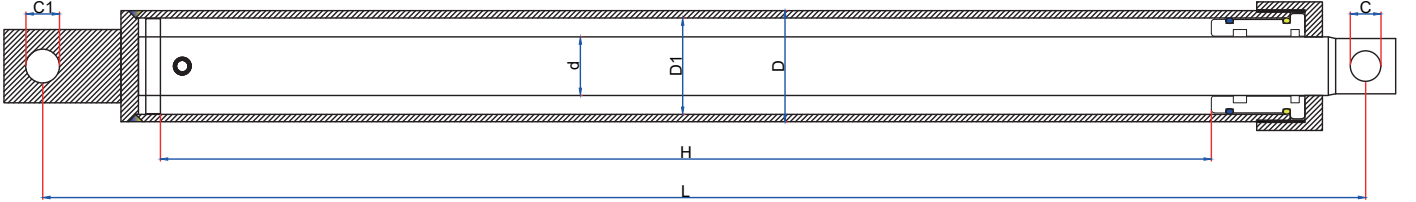

TEKNİK ÖZELLİKLER

Stok Kodu	Ürün Cinsi	Kapasite (Ton)	Kapalı Merkez L - (cm)	Strok H-(mm)	Boru Çapı D1-D (mm)	Mil Çapı d-(mm)
FHR-900	KEPÇE LİFTİ	2	50	350	5*76	40
FHR-901	KEPÇE LİFTİ	2	60	450	5*76	40
FHR-902	KEPÇE LİFTİ	2	68	530	5*76	40
FHR-903	KEPÇE LİFTİ	2	78	630	5*76	40
FHR-904	KEPÇE LİFTİ	2	90	720	5*76	40
FHR-905	KEPÇE LİFTİ	3	68	530	5*90	45
FHR-906	KEPÇE LİFTİ	3	78	630	5*90	45
FHR-907	KEPÇE LİFTİ	3	90	720	5*90	45
FHR-908	KEPÇE LİFTİ	2	78	630	5*76	45
FHR-909	KEPÇE LİFTİ	2	90	720	5*76	45
FHR-910	KOVA LİFTİ	3	53	320	63*75	45
FHR-911	KOVA LİFTİ KİLİTLİ	3	53	320	63*75	45
FHR-912	KOVA LİFTİ	2	53	320	60*70	40
FHR-913	KOVA LİFTİ KİLİTLİ	2	53	320	60*70	40

A
model



B
model

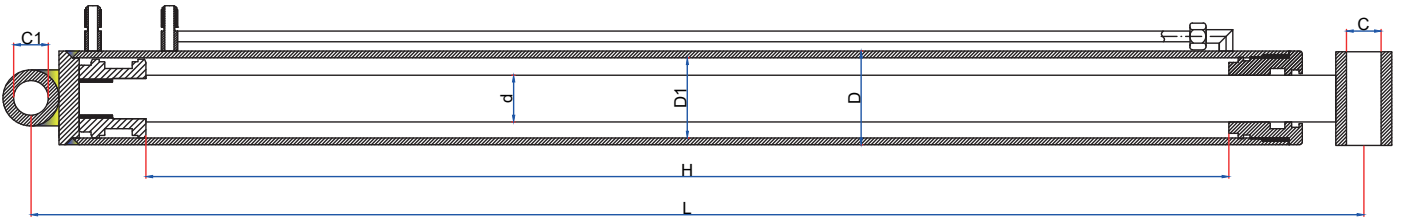
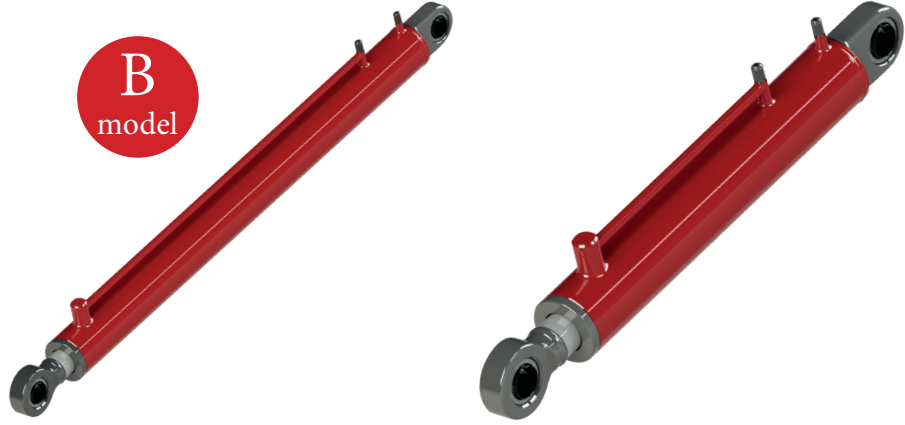

TEKNİK ÖZELLİKLER

Stok Kodu	Ürün Cinsi	Kapasite (Ton)	Kapalı Merkez L - (cm)	Strok H-(mm)	Boru Çapı D1-D (mm)	Mil Çapı d- (mm)
FHR-1000	ÇİFT YÖNLÜ TESİSATLI LİFT	2	40	210	60*70	40
FHR-1001	ÇİFT YÖNLÜ TESİSATLI LİFT	2	50	310	60*70	40
FHR-1002	ÇİFT YÖNLÜ TESİSATLI LİFT	2	60	410	60*70	40
FHR-1003	ÇİFT YÖNLÜ TESİSATLI LİFT	2	70	510	60*70	40
FHR-1004	ÇİFT YÖNLÜ TESİSATLI LİFT	2	80	600	60*70	40
FHR-1005	ÇİFT YÖNLÜ TESİSATLI LİFT	2	90	700	60*70	40
FHR-1006	ÇİFT YÖNLÜ TESİSATLI LİFT	2	100	800	60*70	40

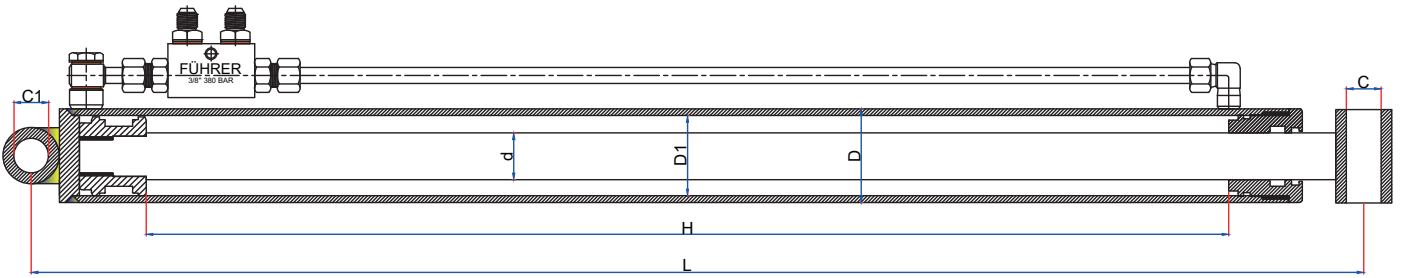

TEKNİK ÖZELLİKLER

Stok Kodu	Ürün Cinsi	Kapasite (Ton)	Kapalı Merkez L - (cm)	Strok H-(mm)	Boru Çapı D1-D (mm)	Mil Çapı d- (mm)
FHR-1100	ÇİFT YÖNLÜ KİLİTLİ LİFT	2	40	210	60*70	40
FHR-1101	ÇİFT YÖNLÜ KİLİTLİ LİFT	2	50	310	60*70	40
FHR-1102	ÇİFT YÖNLÜ KİLİTLİ LİFT	2	60	410	60*70	40
FHR-1103	ÇİFT YÖNLÜ KİLİTLİ LİFT	2	70	510	60*70	40
FHR-1104	ÇİFT YÖNLÜ KİLİTLİ LİFT	2	80	600	60*70	40
FHR-1105	ÇİFT YÖNLÜ KİLİTLİ LİFT	2	90	700	60*70	40
FHR-1106	ÇİFT YÖNLÜ KİLİTLİ LİFT	2	100	800	60*70	40

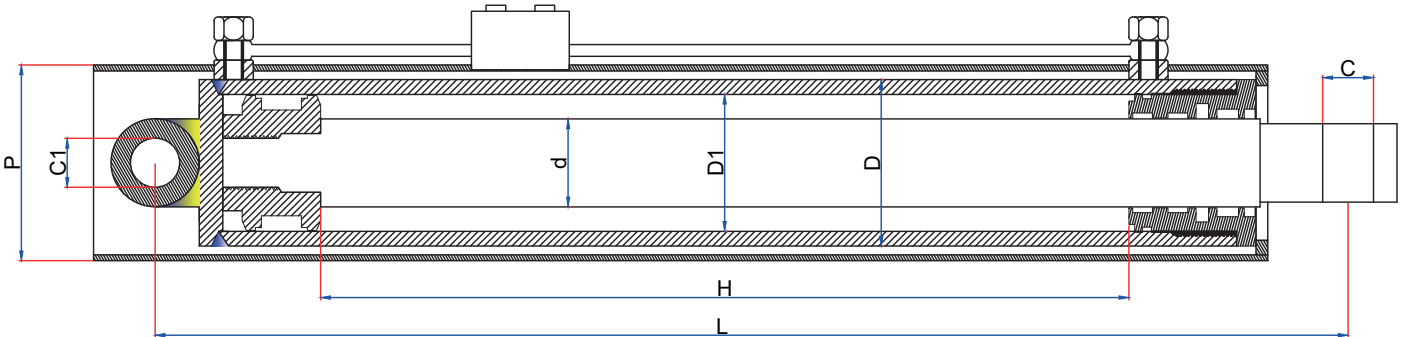
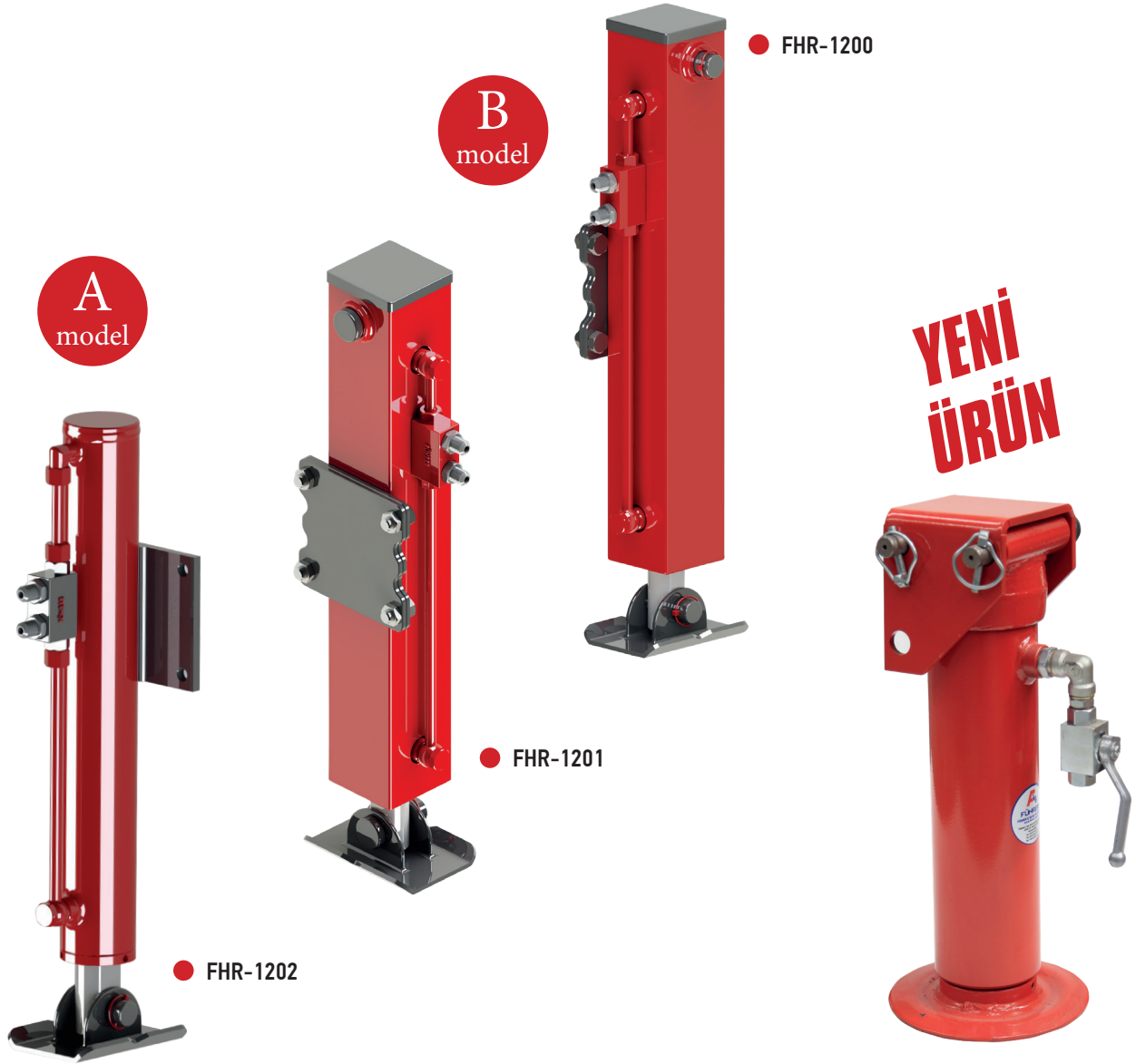

TEKNİK ÖZELLİKLER

Stok Kodu	Ürün Cinsi	Kapasite (Ton)	Kapalı Merkez L - (cm)	Strok H-(mm)	Tip	Profil Ebatı P - (mm)	Boru Çapı D1-D (mm)	Mil Çapı d - (mm)
FHR-1200	HİDROLİK RÖMORK KRİKOLARI	3	61	420	KİLİTLİ	90*90	60*70	40
FHR-1201	HİDROLİK RÖMORK KRİKOLARI	6	61	420	KİLİTLİ	100*100	70*80	45
FHR-1202	HİDROLİK RÖMORK KRİKOLARI	5	59	420	KİLİTLİ	-	63*75	45

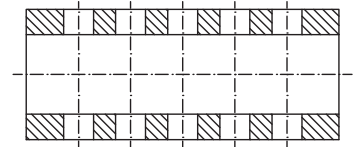
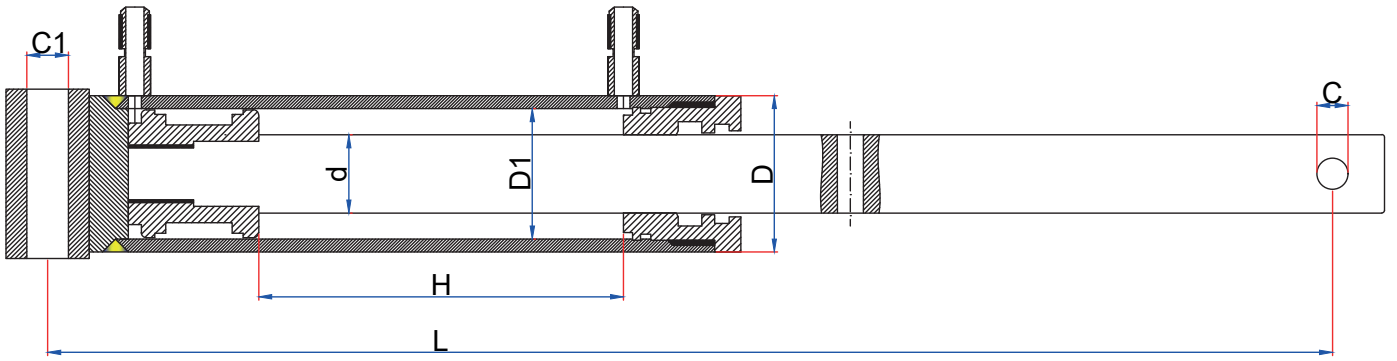
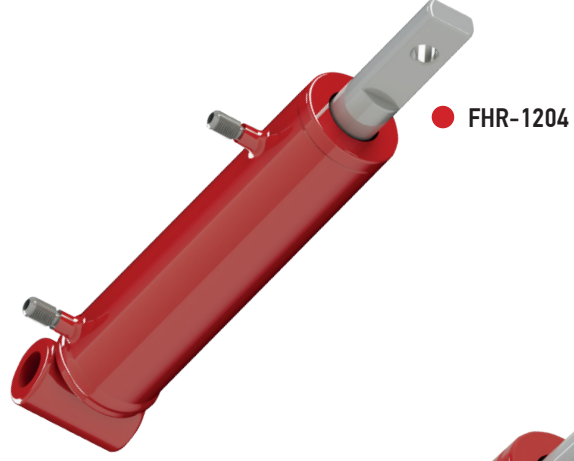

TEKNİK ÖZELLİKLER

Stok Kodu	Ürün Cinsi	Kapalı Merkez L - (cm)	Strok H-(mm)	Boru Çapı D1 - D (mm)	Mil Çapı d- (mm)
FHR-1203	MİBZER LİFTİ	42	130	50*60	30
FHR-1204	MİBZER LİFTİ	33	130	50*60	30
FHR-1205	MİBZER LİFTİ	26	65	50*60	30



TEKNİK ÖZELLİKLER

Stok Kodu	Ürün Cinsi	Kapalı Merkez L - (cm)	Strok H - (mm)	Boru Çapı D1-D (mm)	Mil Çapı d - (mm)
FHR-1300	DEPO LİFTİ	72.5	832	80x90	40
FHR-1301	DİNGİL LİFTİ	33	168	63x75	40
FHR-1302	TIRMIK LİFTİ	45	300	50x60	30
FHR-1303	TABLA LİFTİ	52.5	320	50x60	25
FHR-1304	FINDIK PATOZ LİFTİ	90	720	60x70	40
FHR-1305	FINDIK PATOZ LİFTİ	70	520	60x70	40
FHR-1306	OK LİFTİ - TAKIMI	66	420	60x70	35
FHR-1307	ÇATALSIZ FREN LİFTİ	30	183	50x60	30
FHR-1308	ÇATALLI FREN LİFTİ	29	163	50x60	30
FHR-1309	KLAVUZ MARKÖR LİFTİ	48.5	164	32x40	18
FHR-1310	SEPET LİFTİ	70	281	50x60	30
FHR-1311	GOBLE LİFTİ	59	333	90x105	50
FHR-1312	RÖMORK KAPAK LİFTİ	60	400	50x60	30
FHR-1313	RÖMORK KAPAK LİFTİ	70	500	50x60	30
FHR-1314	RÖMORK KAPAK LİFTİ	80	600	50x60	30

HİDROLİK TARIM LİFTLERİ



● FHR-1300



● FHR-1301



● FHR-1302



● FHR-1312 - FHR-1313 - FHR-1314



● FHR-1303



● FHR-1304 / FHR-1305



● FHR-1307 / FHR-1308



● FHR-1309

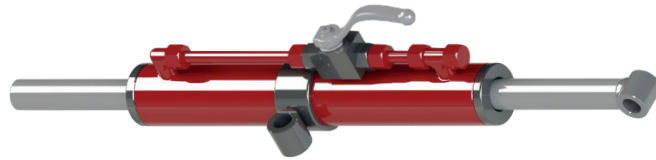

● FHR-1310



● FHR-1311

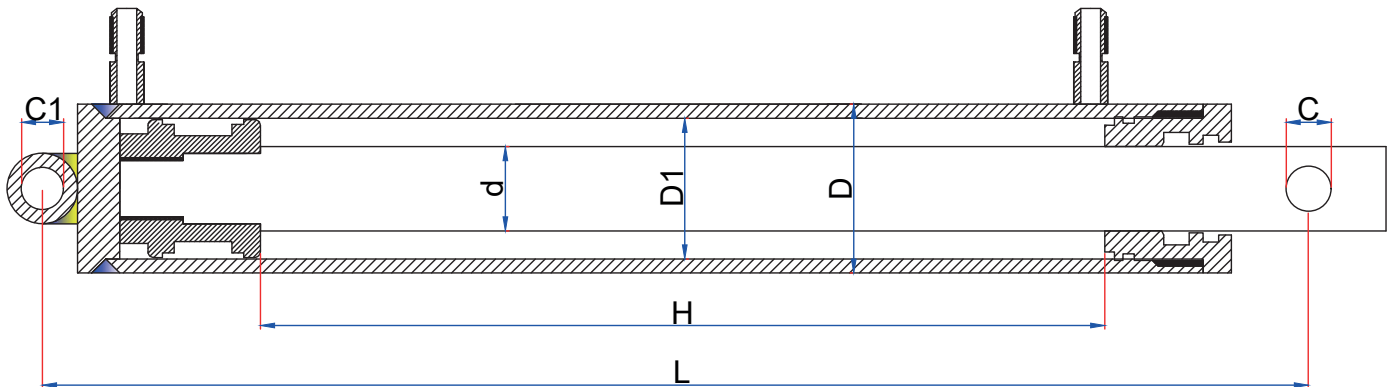

FHR-1400

DESTEK KİT TAKIMLARI



TÜMOSAN



TEKNİK ÖZELLİKLER

Stok Kodu	Ürün Cinsi	Uyumlu Modeller
FHR-1400	TÜMOSAN DESTEK KİT TAKIMI	7000 - 8000

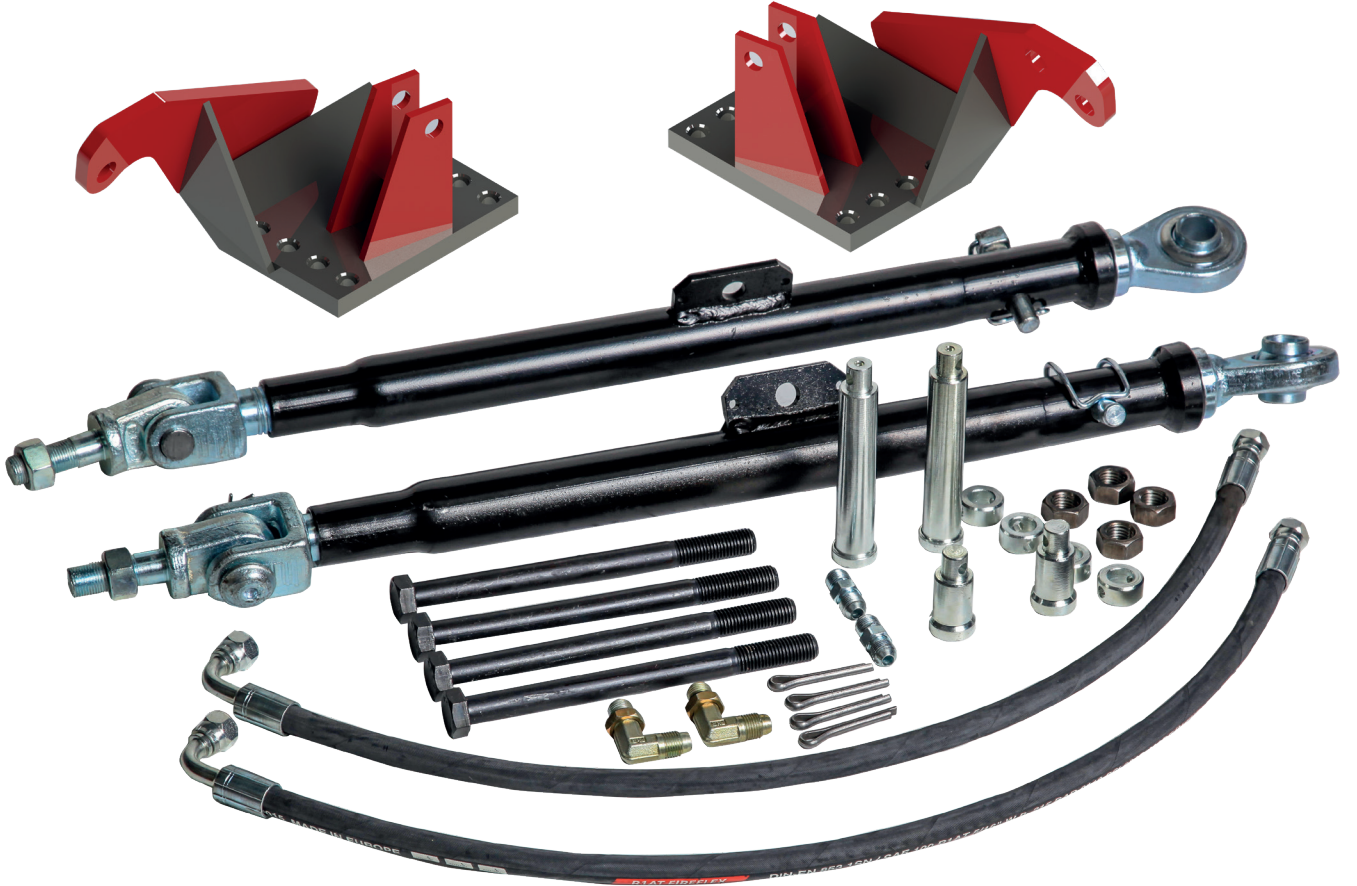
**TEKNİK ÖZELLİKLER**

Stok Kodu	Ürün Cinsi	Uyumlu Modeller
FHR-1401	MASSEY FERGUSON DESTEK KİT TAKIMI	265-285-266G-277G-288G-286G-398-3075-3085-3095-3105

FHR-1402

DESTEK KİT TAKIMLARI



JOHN DEERE



TEKNİK ÖZELLİKLER

Stok Kodu	Ürün Cinsi	Uyumlu Modeller
FHR-1402	JOHNDEERE DESTEK KİT TAKIMI	5050-5060-5065-5075E-5625-2725-5083E-5093E

**TEKNİK ÖZELLİKLER**

Stok Kodu	Ürün Cinsi	Uyumlu Modeller
FHR-1403	FORD DESTEK KİT TAKIMI	5000-5600-6600-6610-6640-7000-7610-7740

GELECEK ÇOK YAKIN...

**TRAKTÖRE DAİR
HERŞEY**

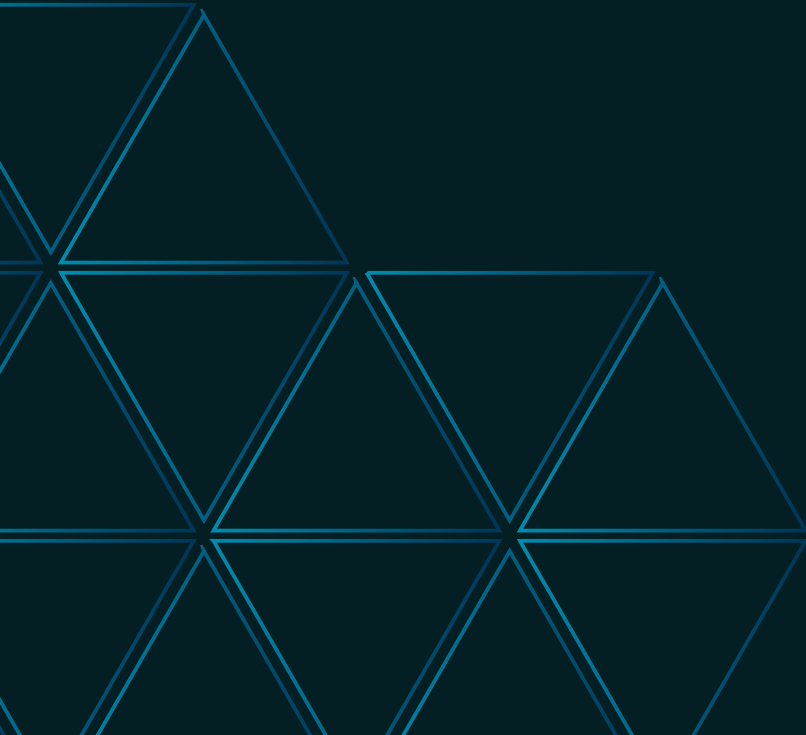

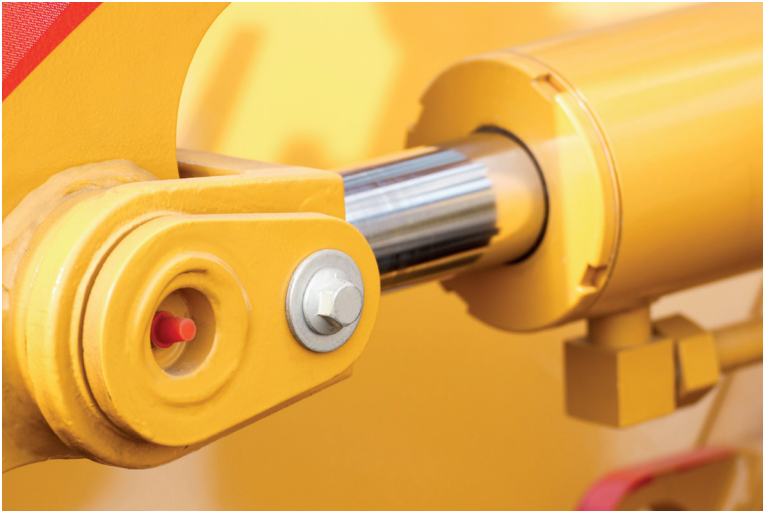

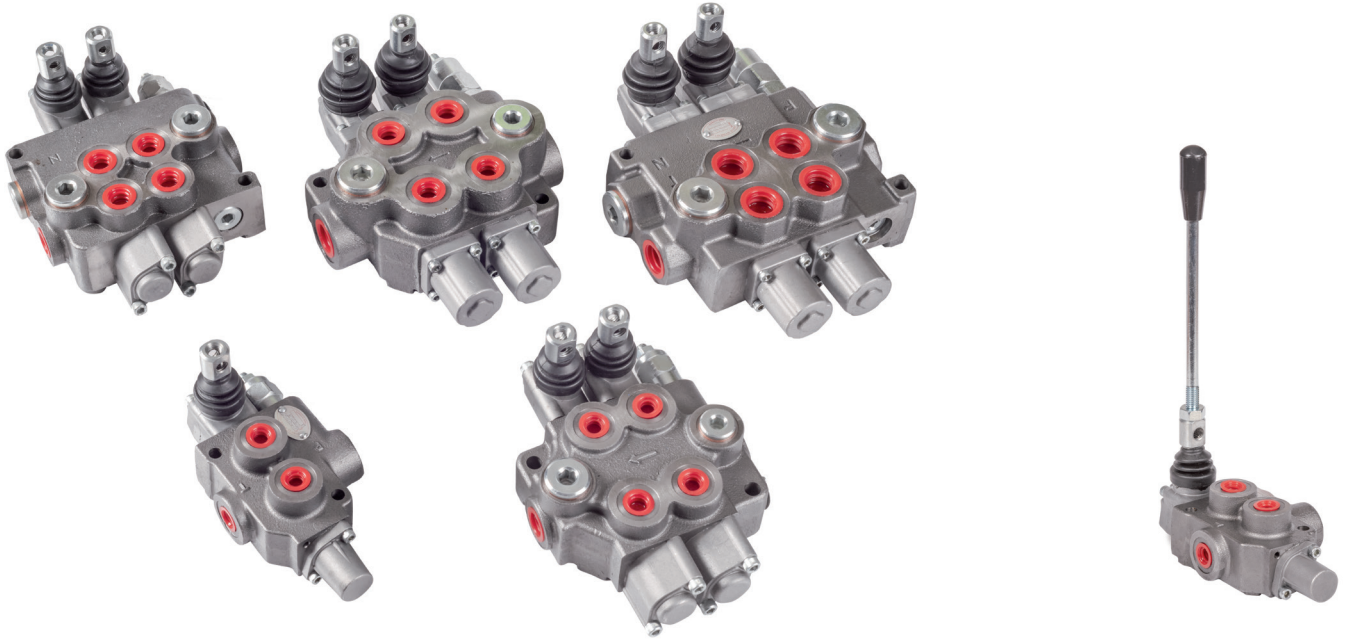

TEKNİK ÖZELLİKLER

Stok Kodu	Tip	Rakor	Litre
FHR-1500	M-40 1P	3/8"-1/2"	40
FHR-1501	M-45 1P	3/8"-1/2"	45
FHR-1502	M-45 2P	3/8"-1/2"	45
FHR-1503	M-45 3P	3/8"-1/2"	45
FHR-1504	M-45 4P	3/8"-1/2"	45
FHR-1505	M-45 5P	3/8"-1/2"	45
FHR-1506	M-45 6P	3/8"-1/2"	45
FHR-1507	MS-45 1P	3/8"-1/2"	45
FHR-1508	MS-45 2P	3/8"-1/2"	45
FHR-1509	MS-45 3P	3/8"-1/2"	45
FHR-1510	MS-45 4P	3/8"-1/2"	45
FHR-1511	MS-45 5P	3/8"-1/2"	45
FHR-1512	MS-45 6P	3/8"-1/2"	45
FHR-1513	MS-45 7P	3/8"-1/2"	45
FHR-1514	M-70 1P	1/2"-3/4"	70
FHR-1515	M-70 2P	1/2"-3/4"	70
FHR-1516	M-70 3P	1/2"-3/4"	70
FHR-1517	M-70 4P	1/2"-3/4"	70
FHR-1518	M-70 5P	1/2"-3/4"	70
FHR-1519	M-70 6P	1/2"-3/4"	70
FHR-1520	M-80 1P	1/2"-3/4"	80
FHR-1521	M-80 2P	1/2"-3/4"	80
FHR-1522	M-80 3P	1/2"-3/4"	80
FHR-1523	M-80 4P	1/2"-3/4"	80
FHR-1524	M-80 5P	1/2"-3/4"	80
FHR-1525	M-80 6P	1/2"-3/4"	80





TEKNİK ÖZELLİKLER

Stok Kodu	Tip	Rakor	Litre
FHR-1600	PD-80 1P	3/4"-1" 1/2"-3/4"	80
FHR-1601	PD-80 2P	1/2"-3/4"	80
FHR-1602	PD-80 3P	1/2"-3/4"	80
FHR-1603	PD-80 4P	1/2"-3/4"	80
FHR-1604	PD-80 5P	1/2"-3/4"	80
FHR-1605	PD-80 6P	1/2"-3/4"	80
FHR-1606	PD-80 7P	1/2"-3/4"	80
FHR-1607	PD-80 8P	1/2"-3/4"	80
FHR-1608	PD-80 9P	1/2"-3/4"	80
FHR-1609	PD-80 10P	1/2"-3/4"	80
FHR-1610	PD-80 11P	1/2"-3/4"	80
FHR-1611	PD-80 12P	1/2"-3/4"	80
FHR-1612	PD-100 1P	1/2"-3/4"	100
FHR-1613	PD-100 2P	1/2"-3/4"	100
FHR-1614	PD-100 3P	1/2"-3/4"	100
FHR-1615	PD-100 4P	1/2"-3/4"	100
FHR-1616	PD-100 5P	1/2"-3/4"	100
FHR-1617	PD-100 6P	1/2"-3/4"	100
FHR-1618	PD-100 7P	1/2"-3/4"	100
FHR-1619	PD-100 8P	1/2"-3/4"	100
FHR-1620	PD-100 9P	1/2"-3/4"	100
FHR-1621	PD-100 10P	1/2"-3/4"	100
FHR-1622	PD-100 11P	1/2"-3/4"	100
FHR-1623	PD-100 12P	1/2"-3/4"	100
FHR-1624	PD-120 1P	1/2"-3/4"	120
FHR-1625	PD-120 2P	1/2"-3/4"	120
FHR-1626	PD-120 3P	1/2"-3/4"	120
FHR-1627	PD-120 4P	1/2"-3/4"	120
FHR-1628	PD-120 5P	1/2"-3/4"	120
FHR-1629	PD-120 6P	1/2"-3/4"	120
FHR-1630	PD-120 7P	1/2"-3/4"	120
FHR-1631	PD-120 8P	1/2"-3/4"	120
FHR-1632	PD-120 9P	1/2"-3/4"	120
FHR-1633	PD-120 10P	1/2"-3/4"	120
FHR-1634	PD-120 11P	1/2"-3/4"	120
FHR-1635	PD-120 12P	1/2"-3/4"	120
FHR-1636	PD-150 1P	3/4"-1"	150
FHR-1637	PD-150 2P	3/4"-1"	150
FHR-1638	PD-150 3P	3/4"-1"	150
FHR-1639	PD-150 4P	3/4"-1"	150
FHR-1640	PD-150 5P	3/4"-1"	150
FHR-1641	PD-150 6P	3/4"-1"	150
FHR-1642	PD-150 7P	3/4"-1"	150
FHR-1643	PD-150 8P	3/4"-1"	150
FHR-1644	PD-150 9P	3/4"-1"	150
FHR-1645	PD-150 10P	3/4"-1"	150
FHR-1646	PD-150 11P	3/4"-1"	150
FHR-1647	PD-150 12P	3/4"-1"	150

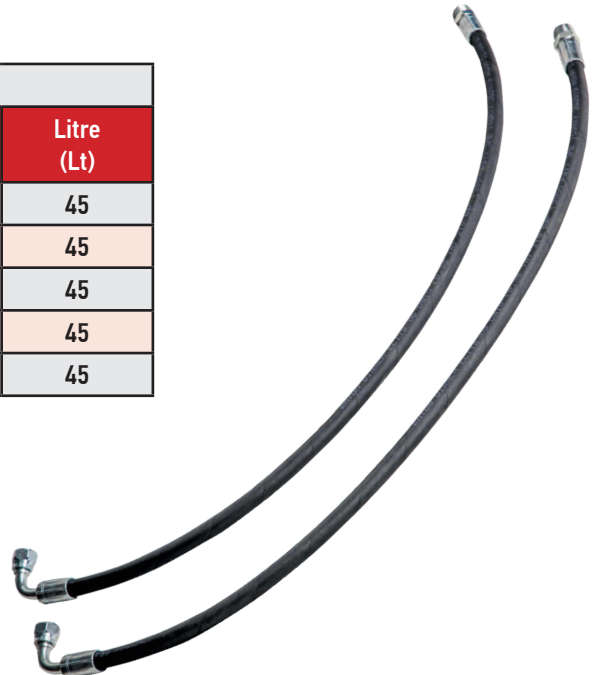
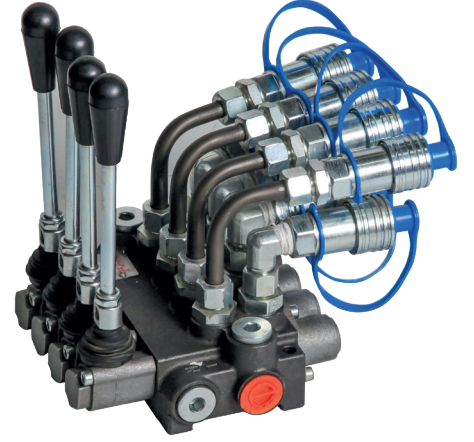
**TEKNİK ÖZELLİKLER**

Stok Kodu	Ürün Cinsi	Rakor	Litre (Lt)
FHR-1526	FHR-M-45 1P	3/8"-1/2"	45
FHR-1527	FHR-M-45 2P	3/8"-1/2"	45
FHR-1528	FHR-M-45 3P	3/8"-1/2"	45
FHR-1529	FHR-M-45 4P	3/8"-1/2"	45
FHR-1530	FHR-M-45 5P	3/8"-1/2"	45

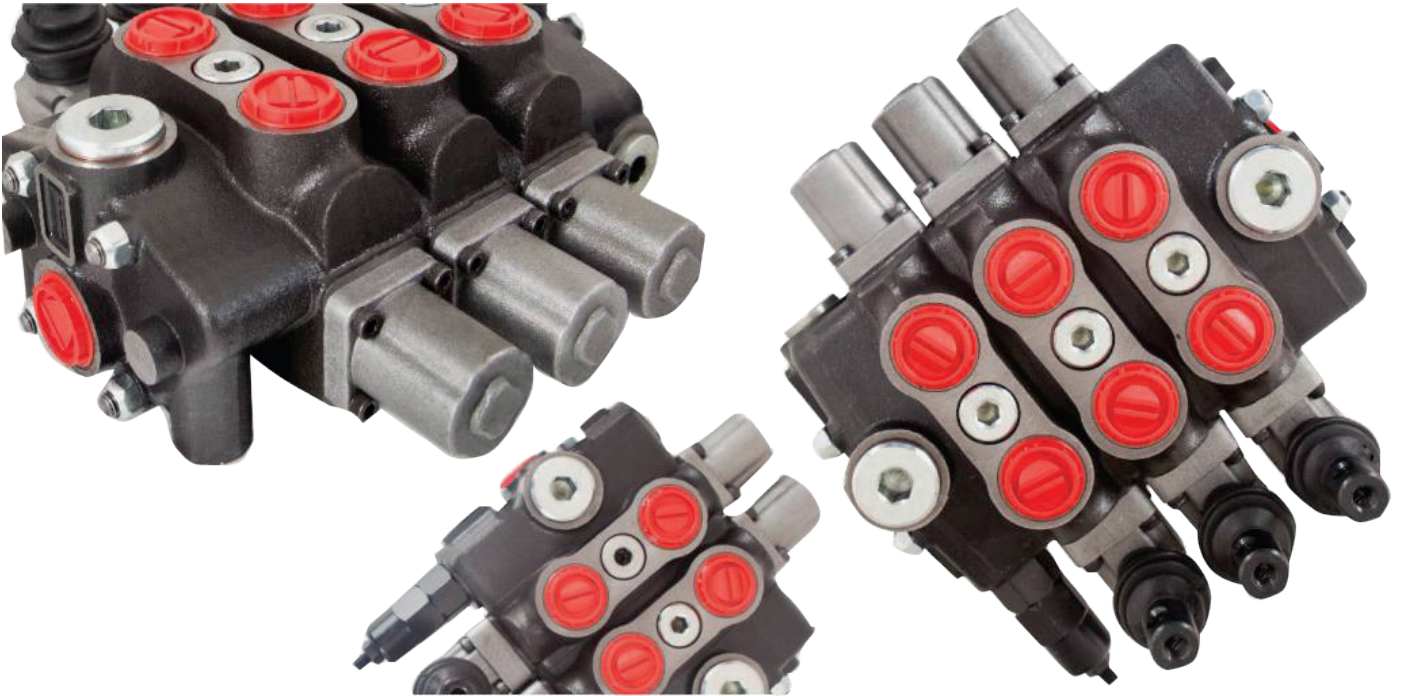
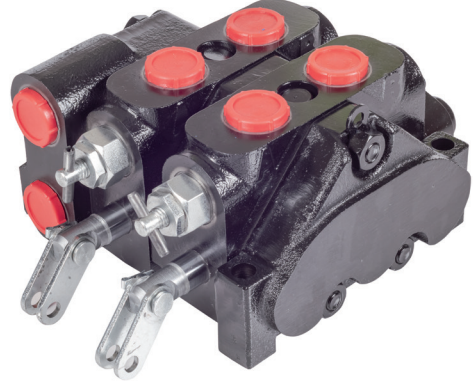
**TEKNİK ÖZELLİKLER**

Stok Kodu	Ürün Cinsi	Rakor	Litre (Lt)
FHR-1669	FHR-DMF-1P	M22x1,5	-
FHR-1670	FHR-DMF-2P	M22x1,5	-
FHR-1671	FHR-DMF-3P	M22x1,5	-

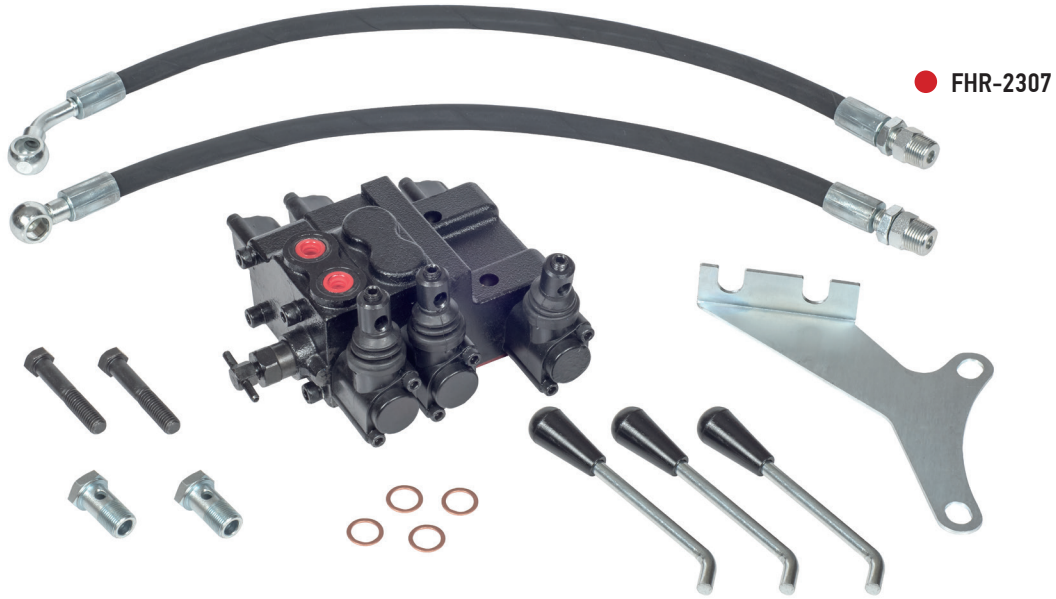
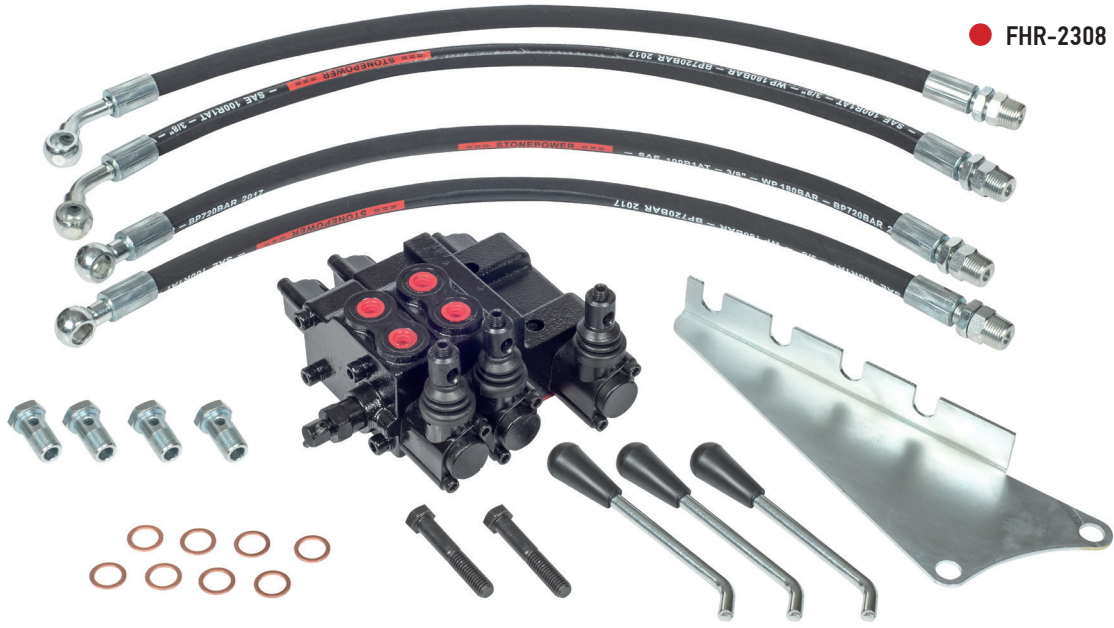

TEKNİK ÖZELLİKLER

Stok Kodu	Ürün Cinsi	Çıkış Sayısı	Rakor
FHR-2306	MASSEY FERGUSON	İKİ ÇIKIŞ	3/8
FHR-2307	MASSEY FERGUSON	İKİ ÇIKIŞ + HİDROLİK	3/8
FHR-2308	MASSEY FERGUSON	DÖRT ÇIKIŞ	3/8
FHR-2309	MASSEY FERGUSON	DÖRT ÇIKIŞ + HİDROLİK	3/8
FHR-2310	MASSEY FERGUSON	ALTI ÇIKIŞ	3/8

● FHR-2304

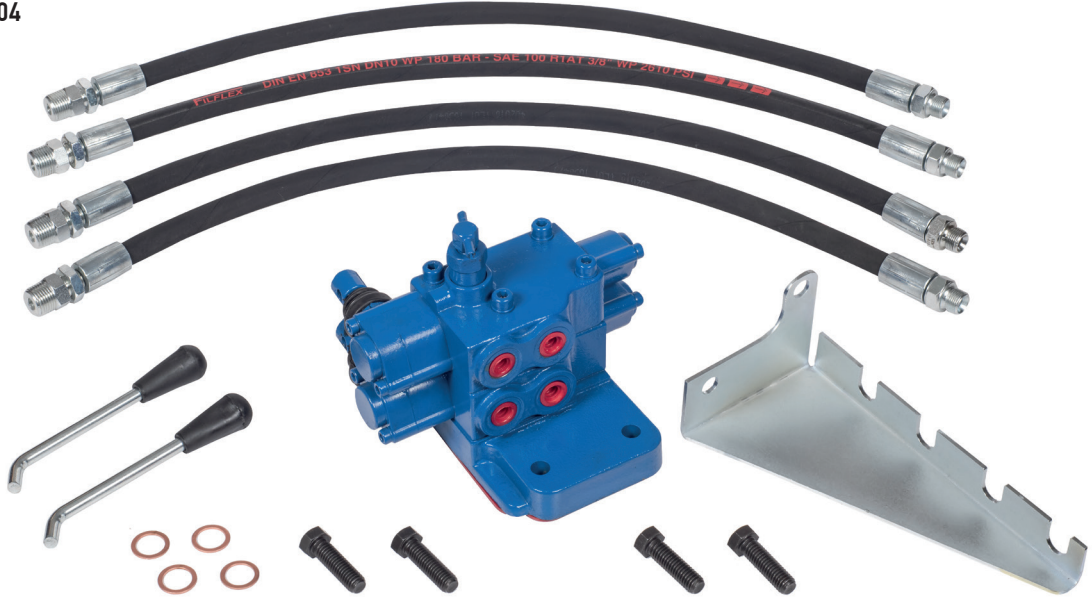

● FHR-2301

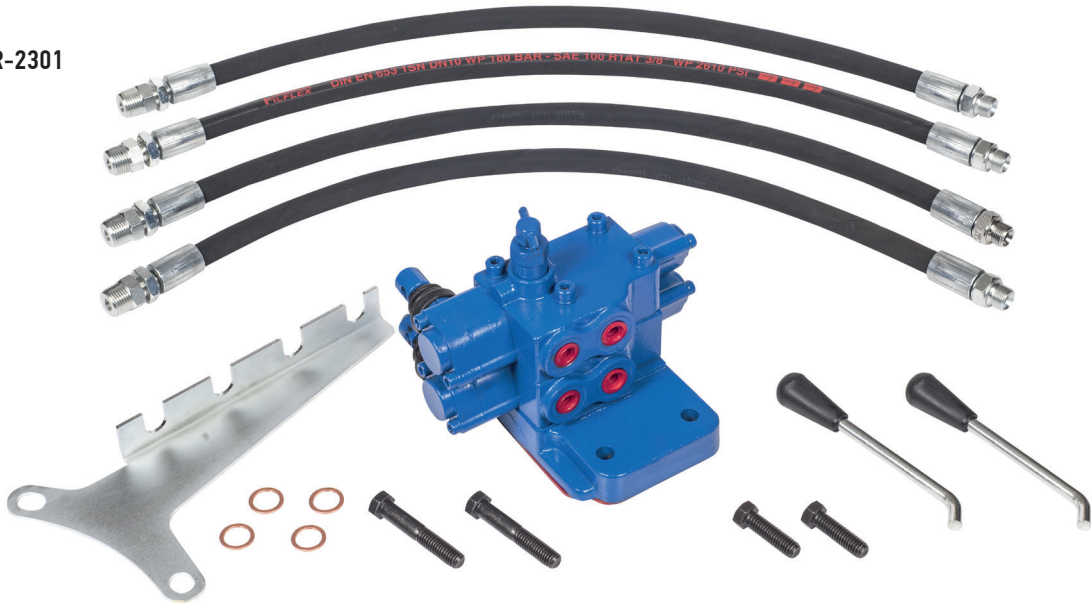

TEKNİK ÖZELLİKLER

Stok Kodu	Ürün Cinsi	Çıkış Sayısı	Rakor
FHR-2300	FORD 3000	İKİ ÇIKIŞ	3/8
FHR-2301	FORD 3000	DÖRT ÇIKIŞ	3/8
FHR-2302	FORD 3000	ALTI ÇIKIŞ	3/8
FHR-2303	FORD 5000	İKİ ÇIKIŞ	3/8
FHR-2304	FORD 5000	DÖRT ÇIKIŞ	3/8
FHR-2305	FORD 5000	ALTI ÇIKIŞ	3/8

FHR-2311

FIAT-DAMPER VALFLERİ



● FHR-2312



TEKNİK ÖZELLİKLER

Stok Kodu	Ürün Cinsi	Çıkış Sayısı	Rakor
FHR-2311	FIAT	İKİ ÇIKIŞ	3/8
FHR-2312	FIAT	DÖRT ÇIKIŞ	3/8
FHR-2313	FIAT	ALTI ÇIKIŞ	3/8

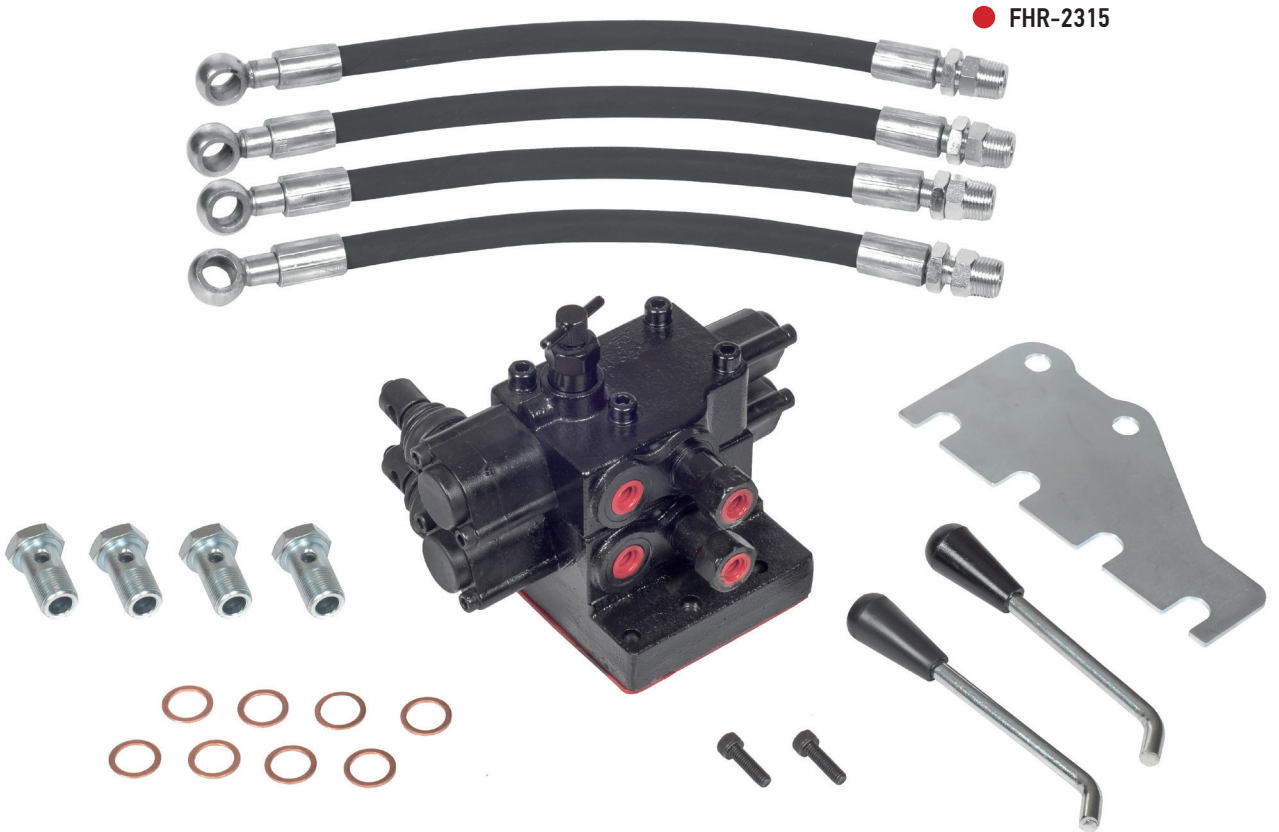
**TEKNİK ÖZELLİKLER**

Stok Kodu	Ürün Cinsi	Çıkış Sayısı	Rakor
FHR-2314	STEYR	İKİ ÇIKIŞ	3/8
FHR-2315	STEYR	DÖRT ÇIKIŞ	3/8
FHR-2316	STEYR	ALTI ÇIKIŞ	3/8

**TEKNİK ÖZELLİKLER**

Stok Kodu	Ürün Cinsi	Rakor	Litre (Lt)
FHR-1666	FHR-TV-50-1P	18 x 1,50	
FHR-1667	FHR-TV-50-2P	18 x 1,50	
FHR-1668	FHR-TV-50-3P	18 x 1,50	

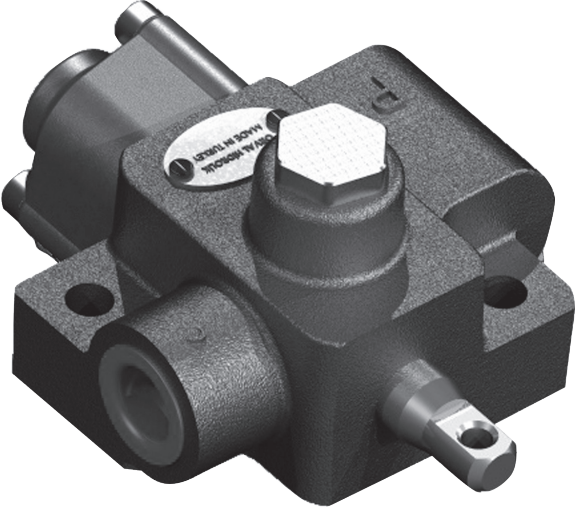
**TEKNİK ÖZELLİKLER**

Stok Kodu	Ürün Cinsi	Rakor	Litre (Lt)
FHR-1672	FHR-RSV-45 - VENTİL	1/2	

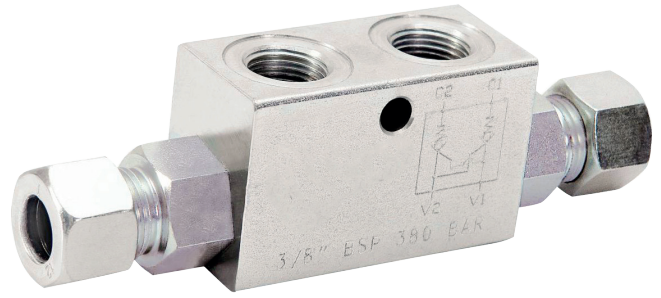
**TEKNİK ÖZELLİKLER**

Stok Kodu	Ürün Cinsi
FHR-1700	1/4 İKİZ KİLİTLEME VALFİ
FHR-1701	3/8 SOMUNSUZ İKİZ KİLİTLEME VALFİ
FHR-1702	1/2 İKİZ KİLİTLEME VALFİ
FHR-1703	3/8 SOMUNLU İKİZ KİLİTLEME VALFİ
FHR-1704	1/2 BASINÇ EMNİYET VALFİ

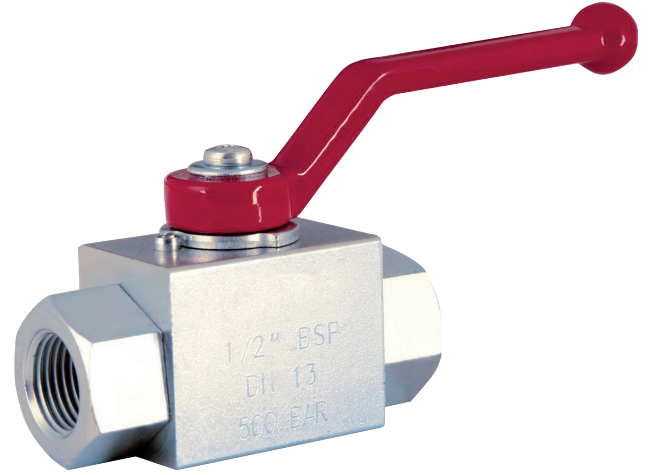
**TEKNİK ÖZELLİKLER**

Stok Kodu	Ürün Cinsi
FHR-1705	1/4 HİDROLİK KÜRESEL VANA
FHR-1706	3/8 HİDROLİK KÜRESEL VANA
FHR-1707	1/2 HİDROLİK KÜRESEL VANA
FHR-1708	3/4 HİDROLİK KÜRESEL VANA
FHR-1709	1" HİDROLİK KÜRESEL VANA
FHR-1710	1-1/4 HİDROLİK KÜRESEL VANA
FHR-1711	1-1/2 HİDROLİK KÜRESEL VANA

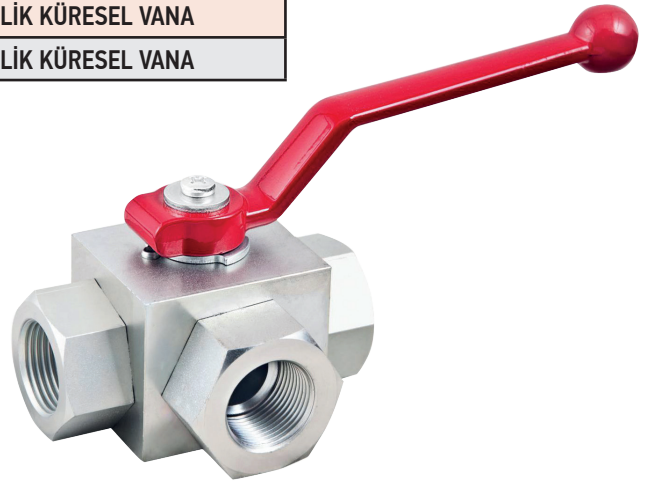
**TEKNİK ÖZELLİKLER**

Stok Kodu	Ürün Cinsi
FHR-1712	1/4 HİDROLİK KÜRESEL VANA
FHR-1713	3/8 HİDROLİK KÜRESEL VANA
FHR-1714	1/2 HİDROLİK KÜRESEL VANA
FHR-1715	3/4 HİDROLİK KÜRESEL VANA
FHR-1716	1" HİDROLİK KÜRESEL VANA
FHR-1717	1-1/4 HİDROLİK KÜRESEL VANA
FHR-1718	1-1/2 HİDROLİK KÜRESEL VANA

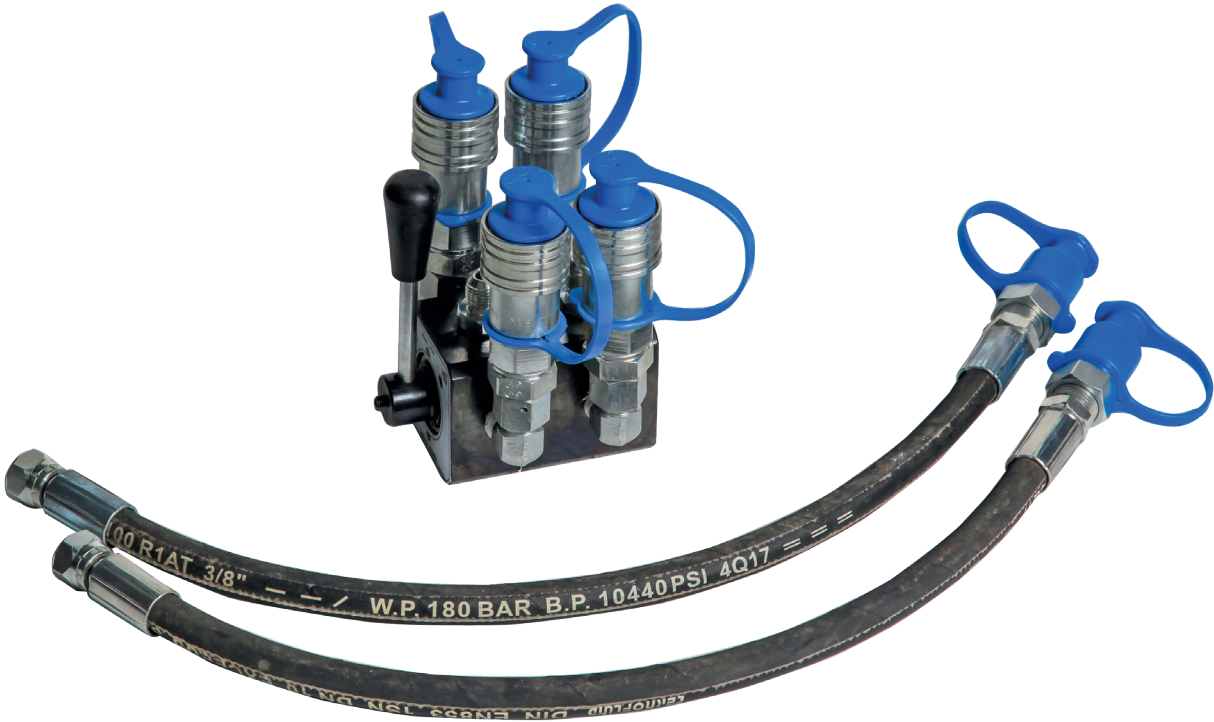
**TEKNİK ÖZELLİKLER**

Stok Kodu	Ürün Cinsi
FHR-1719	3/8 HİDROLİK ALTI YOLLU VANA-TAKIM
FHR-1720	3/4 HİDROLİK ALTI YOLLU VANA

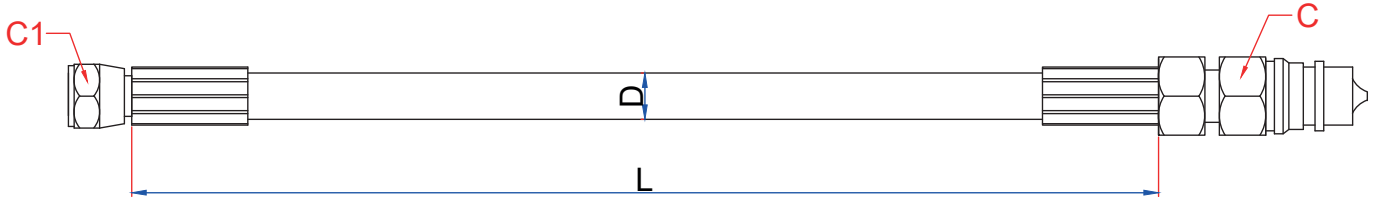
**TEKNİK ÖZELLİKLER**

Stok Kodu	Ürün Cinsi - D	Boy - L (cm)
FHR-1800	3/8 R1-R2 HORTUM	30
FHR-1801	3/8 R1-R2 HORTUM	65
FHR-1802	3/8 R1-R2 HORTUM	70
FHR-1803	3/8 R1-R2 HORTUM	130
FHR-1804	3/8 R1-R2 HORTUM	170
FHR-1805	3/8 R1-R2 HORTUM	200
FHR-1806	3/8 R1-R2 HORTUM	250
FHR-1807	3/8 R1-R2 HORTUM	300

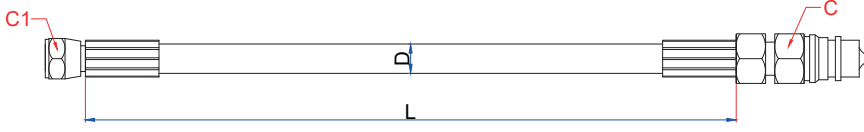

TEKNİK ÖZELLİKLER

Stok Kodu	Ölçü L (cm)
FHR-1825	30 CM
FHR-1826	35 CM
FHR-1827	40 CM
FHR-1828	45 CM
FHR-1829	50 CM
FHR-1830	55 CM
FHR-1831	60 CM
FHR-1832	65 CM
FHR-1833	70 CM
FHR-1834	75 CM
FHR-1835	80 CM
FHR-1836	85 CM
FHR-1837	90 CM
FHR-1838	95 CM
FHR-1839	100 CM
FHR-1840	105 CM
FHR-1841	110 CM
FHR-1842	115 CM
FHR-1843	120 CM
FHR-1844	125 CM
FHR-1845	130 CM
FHR-1846	135 CM
FHR-1847	140 CM
FHR-1848	145 CM
FHR-1849	150 CM
FHR-1850	155 CM
FHR-1851	160 CM
FHR-1852	165 CM
FHR-1853	170 CM
FHR-1854	175 CM
FHR-1855	180 CM
FHR-1856	185 CM
FHR-1857	190 CM
FHR-1858	195 CM
FHR-1859	200 CM
FHR-1860	250 CM
FHR-1861	300 CM
FHR-1862	350 CM
FHR-1863	400 CM
FHR-1864	450 CM
FHR-1865	500 CM
FHR-1866	550 CM
FHR-1867	600 CM
FHR-1868	650 CM
FHR-1869	700 CM
FHR-1870	750 CM
FHR-1871	800 CM
FHR-1872	850 CM
FHR-1873	900 CM
FHR-1874	950 CM
FHR-1875	1000 CM



● FHR-2401



● FHR-2400

**TEKNİK ÖZELLİKLER**

Stok Kodu	Ürün Cinsi	OEM
FHR-2400	FIAT 450-480-500-540-580-600-640-55.46-65.46	588771
FHR-2401	MF VFD1104	1860100M95

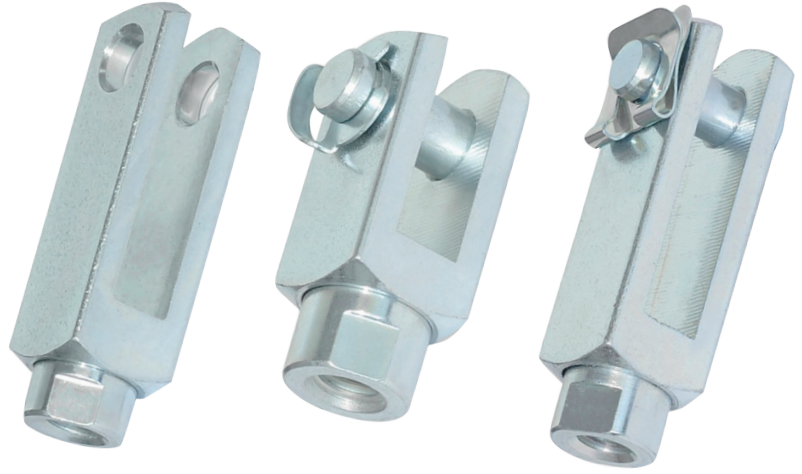

TEKNİK ÖZELLİKLER

Stok Kodu	Ürün Cinsi
FHR-1910	M8X1.25 KLİPSLİ ÇATAL BAĞLANTI
FHR-1911	M10X1.25 KLİPSLİ ÇATAL BAĞLANTI
FHR-1912	M12X1.25 KLİPSLİ ÇATAL BAĞLANTI
FHR-1913	M16X1.5 KLİPSLİ ÇATAL BAĞLANTI
FHR-1914	M20X1.5 KLİPSLİ ÇATAL BAĞLANTI
FHR-1915	M27X2 KLİPSLİ ÇATAL BAĞLANTI



TEKNİK ÖZELLİKLER

Stok Kodu	Ürün Cinsi	Diş Ölçüsü	Pim Ölçüsü
FHR-1916	Q 12/16 PİSTON MAFSAL BAĞLANTI	M6X1.25	6
FHR-1917	Q 20 PİSTON MAFSAL BAĞLANTI	M8X1.25	8
FHR-1918	Q 25/32 PİSTON MAFSAL BAĞLANTI	M10X1.25	10
FHR-1919	Q 40 PİSTON MAFSAL BAĞLANTI	M12X1.25	12
FHR-1920	Q 50 /63 PİSTON MAFSAL BAĞLANTI	M16X1.5	16
FHR-1921	Q 80/100 PİSTON MAFSAL BAĞLANTI	M20X1.5	20
FHR-1922	Q 125 PİSTON MAFSAL BAĞLANTI	M30X2.0	30
FHR-1923	Q 160/200 PİSTON MAFSAL BAĞLANTI	M35X2.0	35

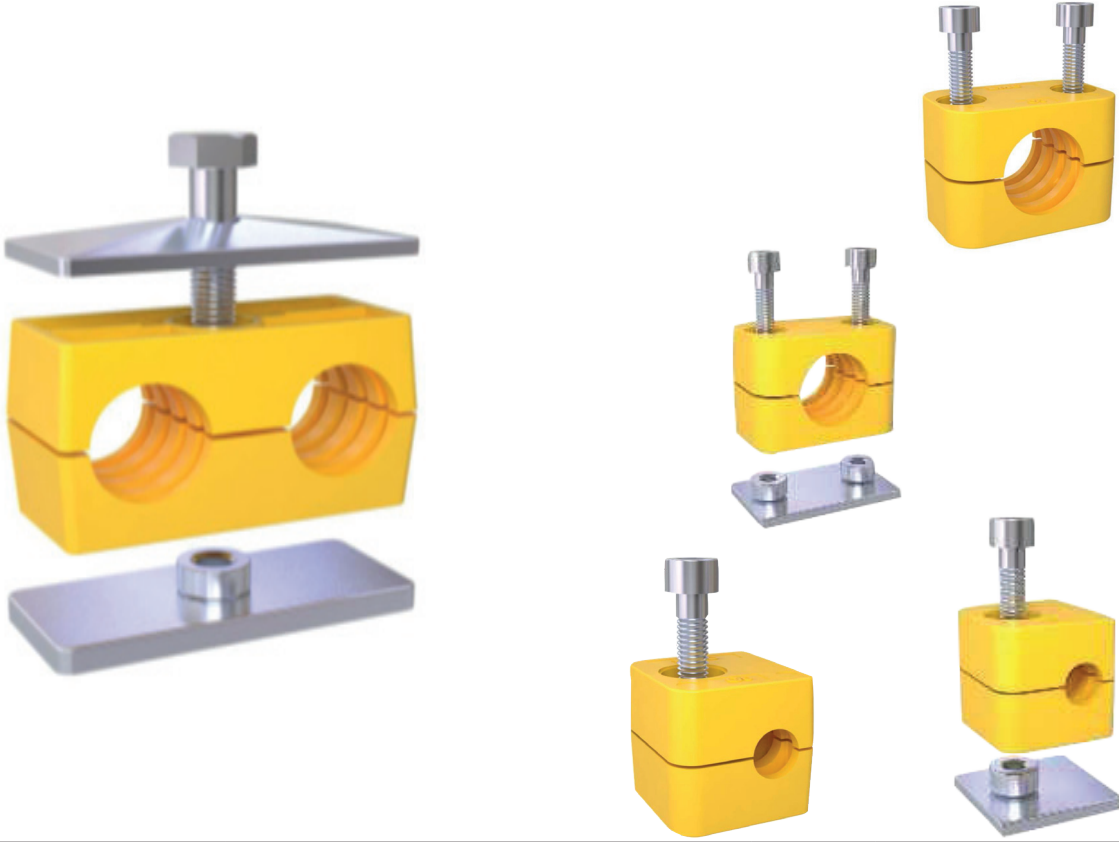

TEKNİK ÖZELLİKLER

Stok Kodu	Ürün Cinsi	Hortum Çapı (mm)	Ürün Cinsi
FHR-1924	BORU VE HORTUM KELEPÇESİ	6	TEKLİ
FHR-1925	BORU VE HORTUM KELEPÇESİ	8	TEKLİ
FHR-1926	BORU VE HORTUM KELEPÇESİ	10	TEKLİ
FHR-1927	BORU VE HORTUM KELEPÇESİ	12	TEKLİ
FHR-1928	BORU VE HORTUM KELEPÇESİ	14	TEKLİ
FHR-1929	BORU VE HORTUM KELEPÇESİ	16	TEKLİ
FHR-1930	BORU VE HORTUM KELEPÇESİ	18	TEKLİ
FHR-1931	BORU VE HORTUM KELEPÇESİ	20	TEKLİ
FHR-1932	BORU VE HORTUM KELEPÇESİ	25	TEKLİ
FHR-1933	BORU VE HORTUM KELEPÇESİ	30	TEKLİ
FHR-1934	BORU VE HORTUM KELEPÇESİ	6	ÇİFTLİ
FHR-1935	BORU VE HORTUM KELEPÇESİ	8	ÇİFTLİ
FHR-1936	BORU VE HORTUM KELEPÇESİ	10	ÇİFTLİ
FHR-1937	BORU VE HORTUM KELEPÇESİ	12	ÇİFTLİ
FHR-1938	BORU VE HORTUM KELEPÇESİ	14	ÇİFTLİ
FHR-1939	BORU VE HORTUM KELEPÇESİ	16	ÇİFTLİ
FHR-1940	BORU VE HORTUM KELEPÇESİ	18	ÇİFTLİ
FHR-1941	BORU VE HORTUM KELEPÇESİ	20	ÇİFTLİ
FHR-1942	BORU VE HORTUM KELEPÇESİ	25	ÇİFTLİ
FHR-1943	BORU VE HORTUM KELEPÇESİ	30	ÇİFTLİ

FHR-1808

RAKOR VE PUL

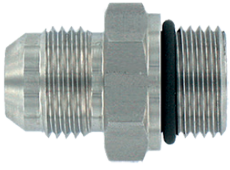

TEKNİK ÖZELLİKLER

Stok Kodu	Ürün Cinsi
FHR-1808	1/2 DİŞİ JAK
FHR-1809	1/2 ERKEK JAK
FHR-1810	1/2 VANA
FHR-1811	3/8-5/8 NİPEL
FHR-1812	3/8-1/4 NİPEL
FHR-1813	1/2-3/4 NİPEL
FHR-1814	1/2-5/8 NİPEL
FHR-1815	3/8-M18 NİPEL

FHR-1816



TEKNİK ÖZELLİKLER

Stok Kodu	Ürün Cinsi
FHR-1816	1/8" BAKIR PUL
FHR-1817	1/4" BAKIR PUL
FHR-1818	3/8" BAKIR PUL
FHR-1819	1/2" BAKIR PUL
FHR-1820	3/4" BAKIR PUL
FHR-1821	1" BAKIR PUL
FHR-1822	1-1/4" BAKIR PUL
FHR-1823	1-1/2" BAKIR PUL
FHR-1824	2" BAKIR PUL



TEKNİK ÖZELLİKLER

Stok Kodu	Ürün Cinsi
FHR-1900	25 CC TULUMBA TİPİ EL BOMBASI
FHR-1901	25 CC TEK TESİRLİ EL BOMBASI
FHR-1902	25 CC ÇİFT TESİRLİ EL BOMBASI
FHR-1903	45 CC TEK TESİRLİ EL BOMBASI
FHR-1904	45 CC ÇİFT TESİRLİ EL BOMBASI



TEKNİK ÖZELLİKLER

Stok Kodu	Ürün Cinsi
FHR-1905	ALÜMİNYUM DEPO 1LT.
FHR-1906	ALÜMİNYUM DEPO 2LT.
FHR-1907	ALÜMİNYUM DEPO 3LT.
FHR-1908	ALÜMİNYUM DEPO 4LT.
FHR-1909	ALÜMİNYUM DEPO 5LT.

FHR-4126**TRAKTÖR KOLTUKLARI****TEKNİK ÖZELLİKLER**

Stok Kodu	Koltuk Özellikleri	Opsiyonlar	Kullanılan Marka	Renk
FHR-4126	MEKANİK SÜSPANSİYON 90 MM	OYNAR SABİT KOLCAK	FORD	PVC SİYAH
	HİDROLİK AMORTİSÖR		FIAT	PVC SARI
	AĞIRLIK AYARI 50-130 KG		MASSEY FERGUSON	PVC MAVİ
	KIZAK HAREKET ALANI 170MM		NEW HOLLAND	PVC KIRMIZI
	DÜZ SIRT			PVC CAMEL
				KUMAŞ SİYAH
				KUMAŞ KIRMIZI
				KUMAŞ ANTRASİT

FHR-4127**TEKNİK ÖZELLİKLER**

Stok Kodu	Koltuk Özellikleri	Opsiyonlar	Kullanılan Marka	Renk
FHR-4127	MEKANİK SÜSPANSİYON 90 MM	OYNAR SABİT KOLCAK	FORD	PVC SİYAH
	HİDROLİK AMORTİSÖR		FIAT	PVC SARI
	AĞIRLIK AYARI 50-130 KG		MASSEY FERGUSON	PVC MAVİ
	KIZAK HAREKET ALANI 170MM		NEW HOLLAND	PVC KIRMIZI
	ACI AYARLI 0-12-20 DERECE		JOHN DEERE	PVC CAMEL
	DÜZ SIRT		STEYR	KUMAŞ SİYAH
				KUMAŞ KIRMIZI
				KUMAŞ ANTRASİT



TEKNİK ÖZELLİKLER

Stok Kodu	Koltuk Özellikleri	Opsiyonlar	Kullanılan Marka	Renk
FHR-56	MEKANİK SÜSPANSİYON 90 MM	OYNAR SABİT KOLCAK	FORD	PVC SİYAH
	HİDROLİK AMORTİSÖR		FİAT	PVC SARI
	AĞIRLIK AYARI 50-130 KG		MASSEY FERGUSON	PVC MAVİ
	KIZAK HAREKET ALANI 170MM		NEW HOLLAND	PVC KIRMIZI
	SABİT KOLCAKLI SIRT			PVC CAMEL
				KUMAŞ SİYAH
				KUMAŞ KIRMIZI
				KUMAŞ ANTRASİT



TEKNİK ÖZELLİKLER

Stok Kodu	Koltuk Özellikleri	Opsiyonlar	Kullanılan Marka	Renk
FHR-57	MEKANİK SÜSPANSİYON 90 MM	SABİT KOLÇAK	FORD	PVC SİYAH
	HİDROLİK AMORTİSÖR		FİAT	PVC SARI
	AĞIRLIK AYARI 50-130 KG		MASSEY FERGUSON	PVC MAVİ
	KIZAK HAREKET ALANI 170MM		NEW HOLLAND	PVC KIRMIZI
	ACI AYARLI 0-12-20 DERECE		JOHN DEERE	PVC CAMEL
	SAB. KOLÇAKLI SIRT		STEYR	KUMAŞ SİYAH
				KUMAŞ KIRMIZI
				KUMAŞ ANTRASİT

**TEKNİK ÖZELLİKLER**

Stok Kodu	Ürün Cinsi
FHR-58	OYNAR KOLÇAK
FHR-59	KENDİNDEN KOLÇAKLI SIRTLIK
FHR-60	DÜZ SIRTLIK
FHR-61	TEK ALTLIK
FHR-62	AMORTİSÖR

TRAKTÖR KOMPRESÖRÜ

FHR-4600



TEKNİK ÖZELLİKLER

Stok Kodu	Ürün Cinsi
FHR-4600	TRAKTÖR HAVA KOMPRESÖRÜ (YAZAN)
FHR-4601	TRAKTÖR HAVA KOMPRESÖRÜ (FÜHRER)

TRAKTÖR ÇEKİ DEMİRLERİ

FHR-4700

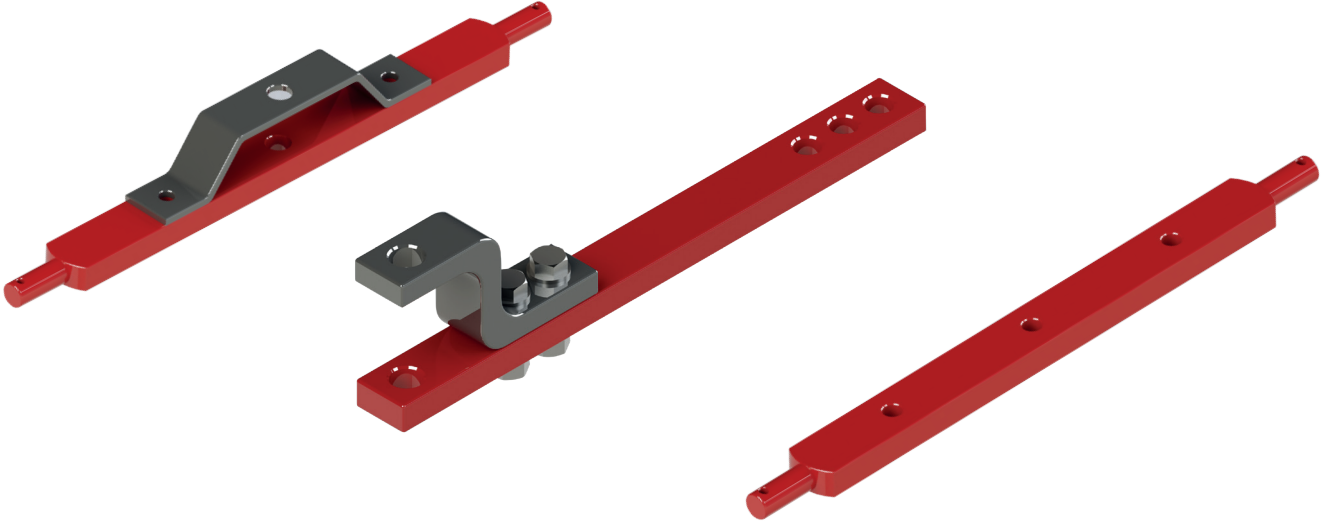

TEKNİK ÖZELLİKLER

Stok Kodu	Ürün Cinsi	Lama Kalınlık (mm)	Lama Eni (mm)	Lama Boyu (mm)
FHR-4700	ÇEKİ OKU	30	60	750
FHR-4701	KÖPRÜLÜ DOKUZ DELİK	30	60	750
FHR-4702	DÜZ DOKUZ DELİK	30	60	750



TEKNİK ÖZELLİKLER

Stok Kodu	Volt	Ürün Cinsi
DZY 12K	12 VOLT	BORU TİP KÜÇÜK DALGIÇ POMPA
DZY 24K	24 VOLT	BORU TİP KÜÇÜK DALGIÇ POMPA
DZY 12B	12 VOLT	BORU TİP BÜYÜK POMPA
DZY 24B	24 VOLT	BORU TİP BÜYÜK POMPA
DZY 12A	12 VOLT	3/4 DIŞTAN ÇEKME ALM. GÖVDE POMPA
DZY 24A	24 VOLT	3/4 DIŞTAN ÇEKME ALM. GÖVDE POMPA
DZY 220D	220 VOLT	3/4 DIŞTAN ÇEKME POMPA
DZY 12-1"	12 VOLT	1" ÇIKIŞLI DIŞTAN ÇEKME POMPA
DZY 24-1"	24 VOLT	1" ÇIKIŞLI DIŞTAN ÇEKME POMPA



Üretim Zinciri

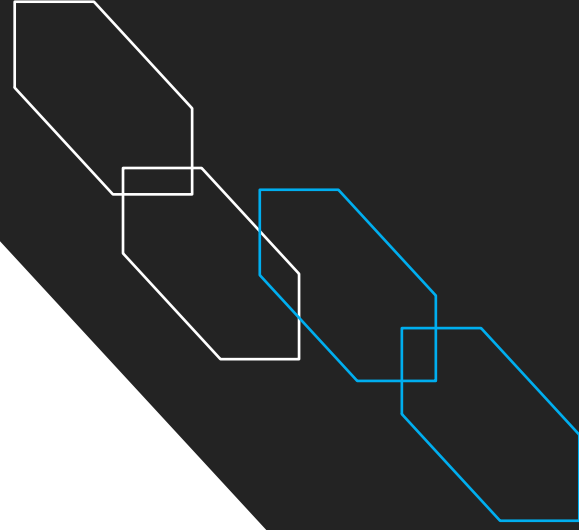



**Herkesin Sahip Olduđu G Yola
ıkınca Belli Olur.**

Her Markanın Bir Ruhunu Vardır



Kkl



alıřkan



Emeki



ÜRÜN ve BEREKET



ÜRETİM BİZİM GENLERİMİZDE VAR...

CAD YAZILIMLARINDA
HAYAT BULAN
HAYALLERİMİZ CNC
TEZGAHLARINDA ELMAS
HASSASLIĞINDA
İŞELENEREK SON ÜRÜN
HALİNE GELİR...







TEKNİK ÖZELLİKLER			
Stok Kodu	Model	Ürün	Ağırlık (kg)
FHR-2200	DÜZ KRİKO	60X60	2000
FHR-2201	EKO- DÜZ KRİKO	60X60	2000
FHR-3000	DÜZ KRİKO	70X70	3000
FHR-3001	EKO- DÜZ KRİKO	70X70	3000
FHR-4000	DÜZ KRİKO	80X80	4000
FHR-4001	EKO- DÜZ KRİKO	80X80	4000

TEKNİK ÖZELLİKLER			
Stok Kodu	Model	Ürün	Ağırlık (kg)
FHR-2001	AYARLI KRİKO	60X60	2000
FHR-2002	EKO- AYARLI KRİKO	60X60	2000
FHR-3101	AYARLI KRİKO	70X70	3000
FHR-3102	EKO- AYARLI KRİKO	70X70	3000
FHR-4101	AYARLI KRİKO	80X80	4000
FHR-4102	EKO- AYARLI KRİKO	80X80	4000

TEKNİK ÖZELLİKLER			
Stok Kodu	Model	Ürün	Ağırlık (kg)
FHR-2003	ŞANZIMANLI KRİKO	60X60	2000
FHR-3003	ŞANZIMANLI KRİKO	70X70	3000
FHR-4002	ŞANZIMANLI KRİKO	80X80	5000



**TEKNİK ÖZELLİKLER**

Stok Kodu	Ürün Cinsi
FHR-4703	ORTA KOL TUTACAĞI
FHR-4704	ORTA KOL TUTACAĞI ZİNCİRLİ
FHR-4705	TRAKTÖR KUYRUK MİL FREZE UCU



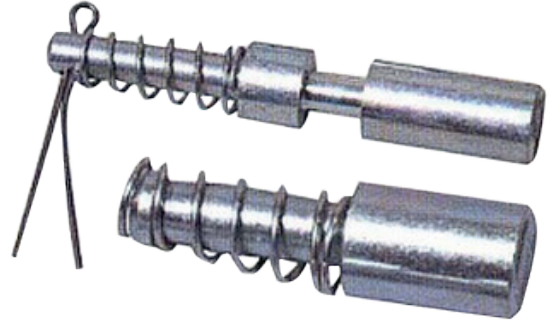
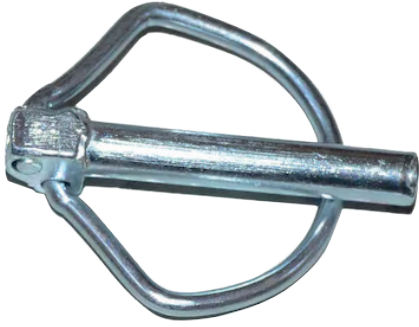

TEKNİK ÖZELLİKLER

Stok Kodu	Ürün Cinsi	Ölçü (mm)
FHR - 4197	YAYLI PİM	6 MM
FHR - 4198	YAYLI PİM	8 MM
FHR - 4199	YAYLI PİM	10 MM
FHR - 4200	YAYLI PİM	11 MM GOLD
FHR - 4201	YAYLI PİM	12 MM GOLD
FHR - 4202	YAYLI PİM	14 MM GOLD
FHR - 4203	YAYLI PİM	16 MM GOLD
FHR - 4204	ŞAFT PİMİ	12 MM UZUN
FHR - 4205	SEMENTELİ ŞAFT PİMİ	12 MM UZUN
FHR - 4206	ŞAFT PİMİ	13 MM KISA
FHR - 4207	ŞAFT PİMİ	13 MM UZUN
FHR - 4208	SEMENTELİ ŞAFT PİMİ	13 MM KISA
FHR - 4209	SEMENTELİ ŞAFT PİMİ	13 MM UZUN
FHR - 4210	ŞAFT PİMİ	14 MM KISA
FHR - 4211	ŞAFT PİMİ	14 MM UZUN
FHR - 4212	SEMENTELİ ŞAFT PİMİ	14 MM KISA
FHR-4213	SEMENTELİ ŞAFT PİMİ	14 MM UZUN

TEKNİK ÖZELLİKLER	
Stok Kodu	Ürün Cinsi
RFS-01-01	19X125 MM ORTA KOL PİMİ
RFS-01-02	22X125 MM ORTA KOL PİMİ
RFS-01-03	25X125 MM ORTA KOL PİMİ
RFS-01-04	28X125 MM ORTA KOL PİMİ
RFS-01-05	19X125 MM ZİNCİRLİ PİM
RFS-01-06	22X125 MM ZİNCİRLİ PİM
RFS-01-07	25X125 MM ZİNCİRLİ PİM
RFS-01-08	28X125 MM ZİNCİRLİ PİM
RFS-01-17	25X150 MM ZİNCİRLİ PİM
RFS-01-09	19X150 MM ORTA KOL PİMİ
RFS-01-10	22X150 MM ORTA KOL PİMİ
RFS-01-11	25X150 MM ORTA KOL PİMİ
RFS-01-12	19X250 MM KIRMASIZ PİM
RFS-01-13	19X170 MM ORTA KOL PİMİ
RFS-01-14	22X170 MM ORTA KOL PİMİ
RFS-01-15	22X190 MM ORTA KOL PİMİ
RFS-01-16	22X220 MM ORTA KOL PİMİ



TEKNİK ÖZELLİKLER	
Stok Kodu	Ürün Cinsi
RFS-02-01	25X180 MM REMORK ÇEKİ PİMİ
RFS-02-01-01	25X200 MM REMORK ÇEKİ PİMİ
RFS-02-02	28X180 MM REMORK ÇEKİ PİMİ
RFS-02-02-01	28X200 MM REMORK ÇEKİ PİMİ
RFS-02-03	30X180 MM REMORK ÇEKİ PİMİ
RFS-02-04	32X180 MM REMORK ÇEKİ PİMİ
RFS-02-05	34X180 MM REMORK ÇEKİ PİMİ
RFS-02-06	36X180 MM REMORK ÇEKİ PİMİ
RFS-02-07	25X250 MM REMORK ÇEKİ PİMİ
RFS-02-08	28X250 MM REMORK ÇEKİ PİMİ
RFS-02-09	30X250 MM REMORK ÇEKİ PİMİ
RFS-02-10	32X250 MM REMORK ÇEKİ PİMİ
RFS-02-18	19X180 MM REMORK ÇEKİ ZİNCİRLİ PİM
RFS-02-11	22X180 MM REMORK ÇEKİ ZİNCİRLİ PİM
RFS-02-12	25X180 MM REMORK ÇEKİ ZİNCİRLİ PİM
RFS-02-13	28X180 MM REMORK ÇEKİ ZİNCİRLİ PİM
RFS-02-14	30X180 MM REMORK ÇEKİ ZİNCİRLİ PİM
RFS-02-15	32X180 MM REMORK ÇEKİ ZİNCİRLİ PİM
RFS-02-16	34X180 MM REMORK ÇEKİ ZİNCİRLİ PİM
RFS-02-17	36X180 MM REMORK ÇEKİ ZİNCİRLİ PİM



TEKNİK ÖZELLİKLER

Stok Kodu	Ürün Cinsi
RFS-05-01	28*28 PULLUK TİLLER PİMİ (SOMUNSUZ)
RFS-05-02	25*28 PULLUK TİLLER PİMİ (SOMUNSUZ)
RFS-05-03	22*28 PULLUK TİLLER PİMİ (SOMUNSUZ)
RFS-05-04	25*22 PULLUK TİLLER PİMİ (SOMUNSUZ)
RFS-05-05	25*25 PULLUK TİLLER PİMİ (SOMUNSUZ)
RFS-05-06	22*22 PULLUK TİLLER PİMİ (SOMUNSUZ)
RFS-05-07	25*28 KAZAYAĞI PULLUK TİLLER PİMİ (SOMUNSUZ)
RFS-05-08	28*28 KAZAYAĞI PULLUK TİLLER PİMİ (SOMUNSUZ)
RFS-05-09	22*19 MM (5/8) MİNİ TİLLER PİMİ KÜÇÜK TİP
RFS-05-10	22*19 MM (3/4) MİNİ TİLLER PİMİ BÜYÜK TİP



TEKNİK ÖZELLİKLER

Stok Kodu	Ürün Cinsi
RFS-07-01	12X45 MM TIRMIK PİMİ (EĞRİ BOYUN)
RFS-07-02	16X70 MM TIRMIK PİMİ (EĞRİ BOYUN)
RFS-07-03	16X90 MM TIRMIK PİMİ (EĞRİ BOYUN)
RFS-07-04	19X110 MM TIRMIK PİMİ (EĞRİ BOYUN)



TEKNİK ÖZELLİKLER

Stok Kodu	Ürün Cinsi
RFS-06-01	MF 135 16 MM*90 MM MF ASKI KOL PİMİ İNCE
RFS-06-02	MF 165 19 MM*90 MM MF ASKI KOL PİMİ ORTA
RFS-06-03	MF 285 22 MM*90 MM MF ASKI KOL PİMİ KALIN
RFS-06-04	22X65 MM FİAT ASKI KOL PİMİ 480-640 İNCE
RFS-06-05	25X65 MM MF ASKI KOL PİMİ 480-640 KALIN

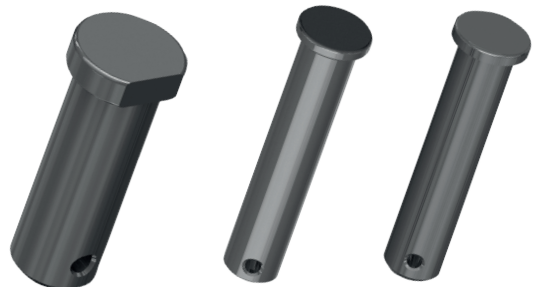



TEKNİK ÖZELLİKLER

Stok Kodu	Ürün Cinsi
RFS-04-01	640 ESKİ MODEL ŞAPKALI HİDROLİK KOL PİMİ
RFS-04-02	480 ESKİ MODEL ŞAPKALI HİDROLİK KOL PİMİ
RFS-04-04	640 SON MODEL 65/46 GÖVDE PERNOSU
RFS-04-05	480 SON MODEL 55/46 GÖVDE PERNOSU
RFS-04-06	640 YENİ MODEL HİDROLİK KOL PERNOSU
RFS-04-07	480 YENİ MODEL HİDROLİK KOL PERNOSU
RFS-04-03	70/56 GÖVDE PERNOSU
RFS-04-09	MF 285 ALT KOŞUM PİMİ



TEKNİK ÖZELLİKLER

Stok Kodu	Ürün Cinsi
RFS-03-01	19X220 MM MF KULAKLI ALT ÇEKİ PİMİ
RFS-03-02	19X250 MM MF KULAKLI ALT ÇEKİ PİMİ
RFS-03-03	19X300 MM MF KULAKLI ALT ÇEKİ PİMİ
RFS-03-04	19X350 MM MF KULAKLI ALT ÇEKİ PİMİ
RFS-03-05	FİAT LAMALI ORTA KOL (SEMER) PİMİ



GLOBAL DÜŞÜNÜYORUZ



Pazarımız Yeryüzü...

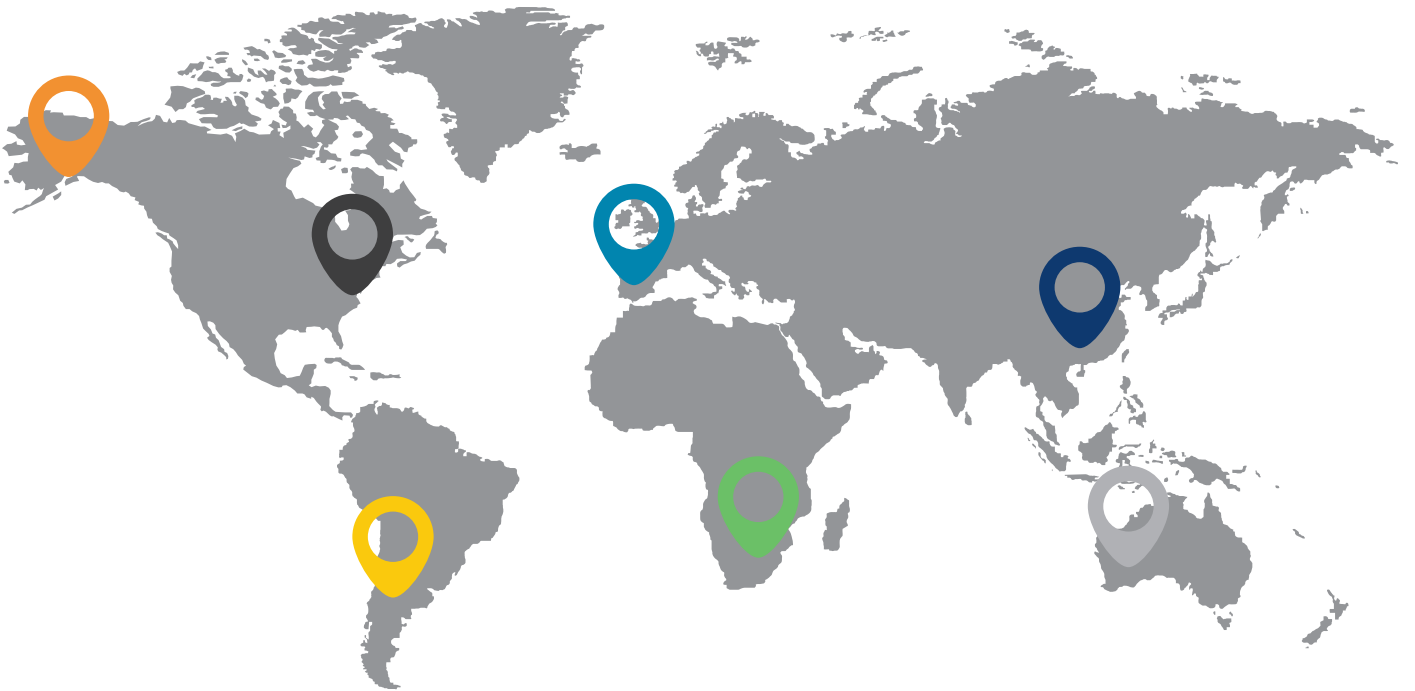



SEKTÖRÜN YÜKSELEN MARKASIYIZ

“ Kısa zamanda hızlı bir yükseliş grafiği sergiledik ve kurumsal yapımızı müşteri memnuniyetine dönüştürdük.”



KİTALARARASI UÇTUK



MÜŞTERİ ODAKLI
FİYAT UYGULADIK



GÜVEN KURDUK



SERVİS



GLOBAL



AR-GE

**Biz Profesyonellik ve
Güçten Doğan
Büyük Biz Aileyiz.**



KURUMSAL



ÇÖZÜM



TEDARİK



Çiftçinin Hidrolik Gücü



FÜHRER İÇ VE DIŞ TİCARET LTD. ŞTİ.
Kobisan 2. Sanayi Sitesi Fevzi Çakmak Mah.
10762. Sk. C Blok No:7/B - 7/C KARATAY/KONYA



T: +90(332) 342 43 23
+90(332) 503 17 20
F: +90(332) 503 17 21



E: harmankaya@fuhrer.com.tr



W: www.fuhrer.com.tr